

# **ANKER FLEXCO**

**TRANSPORTBAND-VERBINDUNGSSYSTEME  
CONVEYOR BELT FASTENING SYSTEMS  
SYSTÈMES D'AGRAFAGE POUR BANDES TRANSPORTEUSES**

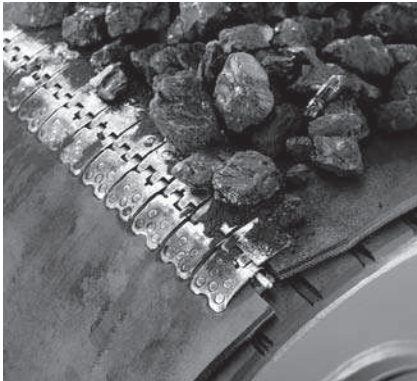

**Programmübersicht**  
Alligator/Flexco/Tatch A Cleat

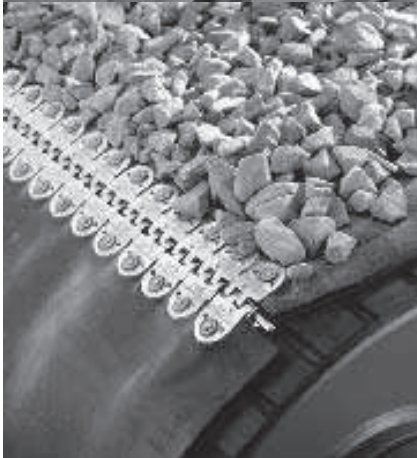

**Program Overview**  
Alligator/Flexco/Tatch A Cleat



**Gamme de produits**  
Alligator/Flexco/Tatch A Cleat

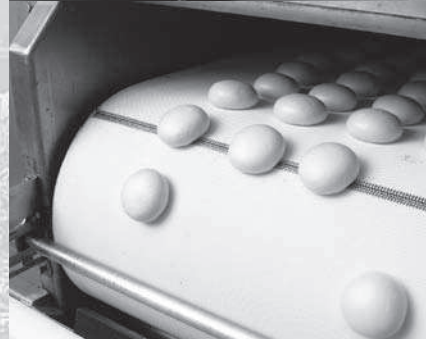
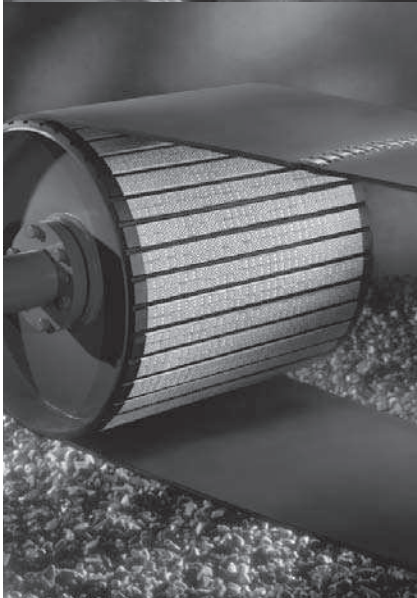



## **ALLIGATOR Lacing**

Transportband - Verbindungssystem für Bandstärken bis 11 mm  
 Conveyor Belt Fastening System for Belts up to 11 mm thick  
 Système d'agrafage pour bandes transporteuses d'épaisseur jusqu'à 11 mm..... 4

## **ALLIGATOR Ready Set**

Transportband - Verbindungssystem für Bandstärken von 1,5 bis 6,4 mm  
 Conveyor Belt Fastening System for Belts 1,5 to 6,4 mm thick  
 Système d'agrafage pour bandes transporteuses d'épaisseur 1,5 - 6,4 mm..... 6

## **ALLIGATOR Rivet**

Transportband - Verbindungssystem für Rundballenpressen  
 Conveyor Belt Fastening System for Round Balers  
 Système d'agrafage pour bandes transporteuses pour presses à balles..... 10

## **ALLIGATOR Plastic Rivet**

Plastikverbinder für Bandstärken von 1,6 - 3,2 mm  
 Plastic Rivet Fasteners for Belts 1,6 - 3,2 mm thick  
 Agrafes plastiques pour bandes transporteuses d'épaisseur 1,6 - 3,2 mm..... 11

## **FLEXCO Rivet Hinged**

Transportband - Verbindungssystem für Bandstärken von 6 bis 25 mm  
 Conveyor Belt Fastening System for Belts 6 to 25 mm thick  
 Système d'agrafage pour bandes transporteuses d'épaisseur 6 - 25 mm..... 12

## **FLEXCO Rivet Solid Plate**

Transportband - Verbindungssystem für Bandstärken von 6 bis 24 mm  
 Conveyor Belt Fastening System for Belts 6 to 24 mm thick  
 Système d'agrafage pour bandes transporteuses d'épaisseur 6 - 24 mm..... 18

## **FLEXCO Bolt Hinged**

Transportband - Verbindungssystem für Bandstärken von 6 bis 16 mm  
 Conveyor Belt Fastening System for Belts 6 to 16 mm thick  
 Système d'agrafage pour bandes transporteuses d'épaisseur 6 - 16 mm..... 20

## **FLEXCO Bolt Solid Plate**

Transportband - Verbindungssystem für Bandstärken von 5 bis 30 mm  
 Conveyor Belt Fastening System for Belts 5 to 30 mm thick  
 Système d'agrafage pour bandes transporteuses d'épaisseur 5 - 30 mm..... 22

## **FLEXCO Bolt Hinged / Bolt Solid Plate**

Extra Schrauben und Muttern  
 Extra Bolts and Nuts  
 Vis et écrous supplémentaires..... 25

## **TATCH A CLEAT**

Schraubstollen und Führungsprofile  
 Mechanical Belt Cleats and Guides  
 Tasseaux et profils de guidage à visser..... 26

## **FLEXCO**

Zubehör für die Bandwartung  
 Belt Maintenance Tools  
 Outillage pour la maintenance des bandes..... 28

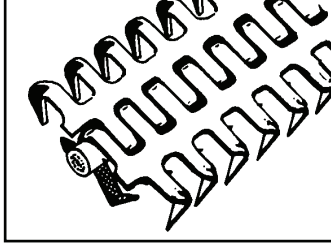

## ALLIGATOR Lacing

Transportband - Verbindungssystem für Bandstärken bis 11 mm

Conveyor Belt Fastening System for Belts up to 11 mm thick

Système d'agrafage pour bandes transporteuses jusqu'à d'épaisseur 11 mm

Verbindergroße Fastener Size Taille des agrafes	empf. Bandstärkenbereich Belt Thickness Range Épaisseur de bandes recommandée mm	empf. kleinster Trommel-Ø rec. min. Pulley-Ø Ø tambour mini.rec. mm
<b>00</b>	- 1,6	25
<b>1</b>	1,6 - 2,4	40
<b>7</b>	2,4 - 3,6	50
<b>15</b>	3,2 - 4,0	65
<b>20</b>	4,0 - 4,8	75

Verbindergroße Fastener Size Taille des agrafes	empf. Bandstärkenbereich Belt Thickness Range Épaisseur de bandes recommandée mm	empf. kleinster Trommel-Ø rec. min. Pulley-Ø Ø tambour mini.rec. mm
<b>25</b>	4,8 - 5,6	100
<b>27</b>	5,6 - 7,1	125
<b>35</b>	7,1 - 7,9	175
<b>45</b>	7,9 - 9,5	230
<b>55</b>	9,5 - 11,0	300

**Inhalt:** Jeder Karton enthält 4 komplette Verbindungen für die angegebene Bandbreite.

**Content:** Each Box contains 4 Sets Lacing for the Belt Width specified.

**Contenu:** Chaque boîte contient 4 jeux complets de jonction pour la largeur de bande spécifiée.

### Stahl / Steel / Acier

Bestell-Nr. Order-No. No. de réf.	Bandbreite Belt Width Larg. de bande mm	Gewicht Weight Poids kg
<b>00</b> (4 Verbindersets / Fastener Sets / Jeux de jonction)		
<b>00-300</b>	300	0,14
<b>00-600</b>	600	0,28
<b>00-900</b>	900	0,42
<b>00-1200</b>	1200	0,57
<b>1A</b>		
<b>1A-300</b>	300	0,25
<b>1A-600</b>	600	0,49
<b>1A-900</b>	900	0,73
<b>1A-1000</b>	1000	0,82
<b>1A-1200</b>	1200	0,98
<b>1A-1500</b>	1500	1,22
<b>7</b>		
<b>7-300</b>	300	0,32
<b>7-600</b>	600	0,64
<b>7-900</b>	900	0,96
<b>7-1000</b>	1000	1,07
<b>7-1200</b>	1200	1,28
<b>7-1500</b>	1500	1,61
<b>15</b>		
<b>15-300</b>	300	0,46
<b>15-600</b>	600	0,91
<b>15-900</b>	900	1,37
<b>15-1200</b>	1200	1,83
<b>20</b>		
<b>20-300</b>	300	0,60
<b>20-600</b>	600	1,20
<b>20-900</b>	900	1,81
<b>20-1200</b>	1200	2,42

### Stahl / Steel / Acier

Bestell-Nr. Order-No. No. de réf.	Bandbreite Belt Width Larg. de bande mm	Gewicht Weight Poids kg
<b>25</b> (4 Verbindersets / Fastener Sets / Jeux de jonction)		
<b>25-300</b>	300	0,68
<b>25-600</b>	600	1,35
<b>25-900</b>	900	2,03
<b>25-1200</b>	1200	2,70
<b>27</b>		
<b>27-300</b>	300	0,80
<b>27-600</b>	600	1,60
<b>27-900</b>	900	2,38
<b>27-1200</b>	1200	3,18
<b>35</b>		
<b>35-300</b>	300	1,28
<b>35-600</b>	600	1,60
<b>35-900</b>	900	3,84
<b>35-1200</b>	1200	5,12
<b>45</b>		
<b>45-300</b>	300	1,51
<b>45-600</b>	600	3,17
<b>45-900</b>	900	4,75
<b>45-1200</b>	1200	6,34
<b>55</b>		
<b>55-300</b>	300	2,17
<b>55-600</b>	600	4,34
<b>55-900</b>	900	6,34
<b>55-1200</b>	1200	8,70

### Rostfrei W.1.4401 / Stainless AISI 316 / Inoxydable Z6CND17-11

Bestell-Nr. Order-No. No. de réf.	Bandbreite Belt Width Larg. de bande mm	Gewicht Weight Poids kg
---	--	----------------------------------

#### 00S (4 Verbindersets / Fastener Sets / Jeux de jonction)

<b>00S-300</b>	300	0,14
<b>00S-600</b>	600	0,28
<b>00S-900</b>	900	0,42
<b>00S-1200</b>	1200	0,57

#### 1S

<b>1S-300</b>	300	0,25
<b>1S-600</b>	600	0,49
<b>1S-900</b>	900	0,73
<b>1S-1000</b>	1000	0,82
<b>1S-1200</b>	1200	0,98
<b>1S-1500</b>	1500	1,22

#### 7S

<b>7S-300</b>	300	0,32
<b>7S-600</b>	600	0,64
<b>7S-900</b>	900	0,96
<b>7S-1000</b>	1000	1,07
<b>7S-1200</b>	1200	1,28
<b>7S-1500</b>	1500	1,61



### Gelenkriemenverbinder Transmission Belt Lacing Agrafes flexibles pour courroies de transmission

### Rostfrei W.1.4401 / Stainless AISI 316 / Inoxydable Z6CND17-11

Bestell-Nr. Order-No. No. de réf.	Verbinder Sets Fastener Sets Jeux de jonction	Gewicht Weight Poids kg
---	---	----------------------------------

<b>00S</b>	6 X 150	0,09
<b>1AS</b>	6 X 150	0,15
<b>7S</b>	6 X 150	0,20
<b>15S</b>	4 X 300	0,41
<b>20S</b>	4 X 300	0,55
<b>25DS</b>	4 X 300	0,64
<b>27KS</b>	4 X 300	0,78
<b>35NS</b>	4 X 300	1,23
<b>45US</b>	4 X 300	1,50
<b>55WS</b>	4 X 300	2,14

### Stahl / Steel / Acier

Bestell-Nr. Order-No. No. de réf.	Verbinder Sets Fastener Sets Jeux de jonction	Gewicht Weight Poids kg
---	---	----------------------------------

<b>00</b>	6 X 150	0,09
<b>1A</b>	6 X 150	0,15
<b>7</b>	6 X 150	0,20
<b>15</b>	4 X 300	0,41
<b>20</b>	4 X 300	0,55
<b>25D</b>	4 X 300	0,64
<b>27K</b>	4 X 300	0,78
<b>35N</b>	4 X 300	1,23
<b>45U</b>	4 X 300	1,50
<b>55W</b>	4 X 300	2,14

### Eco Pack

Jede VPE enthält 10 Verbindersets, einzeln verpackt.

Each package contains 10 sets of lacing, individually packed.

Chaque unité d'emballage comprend 10 jeux de jonction, emballés individuellement.

Bestell-Nr. Order-No. No. de réf.	Verbinder Sets Fastener Sets Jeux de jonction	Gewicht Weight Poids kg
---	---	----------------------------------

<b>15E</b>	10 X 300	0,41
<b>20E</b>	10 X 300	0,55
<b>25E</b>	10 X 300	0,64
<b>27E</b>	10 X 300	0,78
<b>35E</b>	10 X 300	1,23



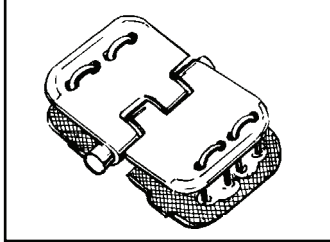

## ALLIGATOR Ready Set

Transportband- Verbindungssystem für Bandstärken von 1,5 - 6,4 mm

Conveyor Belt Fastening System for Belts 1,5 - 6,4 mm thick

Système d'agrafage pour bandes transporteuses d'épaisseur 1,5 - 6,4 mm

Verbindergroße Fastener Size Taille des agrafes	Für Transportbänder bis zu... N/mm Festigkeit For Belts with a Tensile Strength of up to... N/mm Pour bandes tranporteuses à résistance de rupture jusqu'à... N/mm	empf. Bandstärkenbereich Belt Thickness Range Épaisseur de bandes recommandée mm	empf. kleinster Trommel-Ø rec. min. Pulley-Ø Ø tambour mini.rec. mm
<b>RS62</b>	200	1,5 - 3,2	50
<b>RS125</b>	315	3,2 - 4,8	75
<b>RS187</b>	400	4,8 - 6,4	100

**Inhalt:** Jeder J-Karton enthält 4 komplette Verbindungen für die angegebene Bandbreite.

**Content:** Each J-box contains 4 Sets Lacing for the Belt Width specified.

**Contenu:** Chaque boîte J contient 4 jeux complets de jonction pour la largeur de bande spécifiée.

### Stahl verzinkt / Galvanized Steel Acier galvanisé

Bestell-Nr. Order-No. No. de réf.	Bandbreite Belt Width Larg. de bande mm	Gewicht Weight Poids kg
<b>RS62J12/300NC</b>	300	0,61
<b>RS62J24/600NC</b>	600	1,22
<b>RS62J32/800NC</b>	800	1,64
<b>RS62J40/1000NC</b>	1000	2,05
<b>RS62J47/1200NC</b>	1200	2,44
<b>RS62J59/1500NC</b>	1500	3,05
<b>RS125J12/300NC</b>	300	0,91
<b>RS125J24/600NC</b>	600	1,78
<b>RS125J32/800NC</b>	800	2,43
<b>RS125J40/1000NC</b>	1000	3,04
<b>RS125J47/1200NC</b>	1200	3,65
<b>RS125J59/1500NC</b>	1500	4,56
<b>RS187J12/300NC</b>	300	1,16
<b>RS187J24/600NC</b>	600	2,69
<b>RS187J32/800NC</b>	800	3,36
<b>RS187J40/1000NC</b>	1000	4,20
<b>RS187J47/1200NC</b>	1200	5,33
<b>RS187J59/1500NC</b>	1500	6,26

### Rostfrei / Stainless Inoxydable

Bestell-Nr. Order-No. No. de réf.	Bandbreite Belt Width Larg. de bande mm	Gewicht Weight Poids kg
<b>RS62SJ12/300NCS</b>	300	0,61
<b>RS62SJ24/600NCS</b>	600	1,22
<b>RS62SJ32/800NCS</b>	800	1,64
<b>RS62SJ40/1000NCS</b>	1000	2,05
<b>RS62SJ47/1200NCS</b>	1200	2,44
<b>RS62SJ59/1500NCS</b>	1500	3,05
<b>RS125SJ12/300NCS</b>	300	0,91
<b>RS125SJ24/600NCS</b>	600	1,78
<b>RS125SJ32/800NCS</b>	800	2,43
<b>RS125SJ40/1000NCS</b>	1000	3,04
<b>RS125SJ47/1200NCS</b>	1200	3,65
<b>RS125SJ59/1500NCS</b>	1500	4,56
<b>RS187SJ12/300NCS</b>	300	1,16
<b>RS187SJ24/600NCS</b>	600	2,69
<b>RS187SJ32/800NCS</b>	800	3,36
<b>RS187SJ40/1000NCS</b>	1000	4,20
<b>RS187SJ47/1200NCS</b>	1200	5,33
<b>RS187SJ59/1500NCS</b>	1500	6,26

25 Verbindersets (ohne Kupplungsstäbe) · 25 Fastener Sets (without Hinge Pins) · 25 Jeux de jonction (sans axe)

<b>RS62-47/1200-25</b>	1200	13,50
<b>RS125-47/1200-25</b>	1200	18,70
<b>RS187-47/1200-25</b>	1200	27,50

<b>RS62S-47/1200-25</b>	1200	13,50
<b>RS125S-47/1200-25</b>	1200	18,70
<b>RS187S-47/1200-25</b>	1200	27,50

### MegAlloy

Bestell-Nr. Order-No. No. de réf.	Inhalt Content Contenu	Gewicht Weight Poids kg
<b>125MA*</b>	8 X 300 mm	1,9
<b>187MA*</b>	8 X 300 mm	2,6

### Extra Klammern, rostfrei · Extra Staples, stainless Crampons supplémentaires, inoxydables

Bestell-Nr. Order-No. No. de réf.	Verbindergroße Fastener size Taille d'agrafe	Inhalt Content Contenu	Gewicht Weight Poids kg
<b>S125</b>	125	990	0,41
<b>S187</b>	187	990	0,46

\* ohne Kupplungsdrähte / without hinge pins / sans tige de jonction

Montage von MegAlloy Verbindern mit ST4-5 Block (grün) und Klammermagazin C150.  
Installation of MegAlloy fasteners with ST4-5 block (green) and staple dispenser C150.  
Installation des agrafes MegAlloy avec bloc ST4-5 (vert) et chargeur de crampons C150.

<b>Kupplungsdrähte</b> <b>Hinge Material</b> <b>Axes de jonction</b>	Bestell-Nr. Order-No. No. de réf.	Ø mm	Verbindergröße Fastener Size Taille d'agrafe	Inhalt Content Contenu	Gewicht Weight Poids kg
<b>NC</b> Nylostahl Kabel Nylo Stainless Cable Câble nyloacier	<b>NC62-X</b>	2,0	RS62	3 m	0,05
	<b>NC62-C</b>			30 m	0,45
	<b>NC1-X</b>	3,6	RS125	3 m	0,09
	<b>NC1-C</b>			30 m	0,77
<b>NC187-X</b>	5,2	RS187	3 m	0,09	
<b>NC187-C</b>			30 m	2,17	
<b>NCS*</b> Nylorostfrei Kabel Nylo Stainless Cable Câble nyloinox	<b>NCS62-X</b>	2,0	RS62	3 m	0,05
	<b>NCS62-C</b>			30 m	0,45
	<b>NCS1-X</b>	3,6	RS125	3 m	0,09
	<b>NCS1-C</b>			30 m	0,77
<b>NCS187-X</b>	5,2	RS187	3 m	0,09	
<b>NCS187-C</b>			30 m	2,17	
<b>SP</b> Federstahl Spring Steel Acier à ressort * Bandbreite (mm) * Belt Width (mm) * Largeur de bande (mm)	<b>SP62-1000</b>	2,0	RS62	10 X 1000* mm	0,32
	<b>SP62-1200</b>			10 X 1200* mm	0,37
	<b>SP62-1500</b>			10 X 1500* mm	0,40
	<b>SP1-1000</b>	3,6	RS125	10 X 1000* mm	0,68
	<b>SP1-1200</b>			10 X 1200* mm	0,87
	<b>SP1-1500</b>			10 X 1500* mm	1,00
	<b>SP2-1000</b>	4,7	RS187	10 X 1000* mm	1,23
	<b>SP2-1200</b>			10 X 1200* mm	1,55
<b>SP2-1500</b>	10 X 1500* mm			1,80	
<b>SS*</b> Federstahl rostfrei Stainless Spring Steel Acier inoxydable à ressort * Bandbreite (mm) * Belt Width (mm) * Largeur de bande (mm)	<b>SS62-1000</b>	2,0	RS62	10 X 1000* mm	0,32
	<b>SS62-1200</b>			10 X 1200* mm	0,37
	<b>SS62-1500</b>			10 X 1500* mm	0,42
	<b>SS1-1000</b>	3,6	RS125	10 X 1000* mm	0,68
	<b>SS1-1200</b>			10 X 1200* mm	0,87
	<b>SS1-1500</b>			10 X 1500* mm	1,00
	<b>SS2-1000</b>	4,7	RS187	10 X 1000* mm	1,23
	<b>SS2-1200</b>			10 X 1200* mm	1,55
<b>SS2-1500</b>	10 X 1500* mm			1,95	
Kupplungsstab-Sicherungs- scheiben	<b>62-RET-50</b>		RS62	50	0,04
	<b>125-RET-50</b>		RS125	50	0,05
Hinge Pin Retaining Washers	<b>187-RET-50</b>		RS187	50	0,06
Rondelles de butée pour axes de jonction	<b>310-RET-50</b>		375X/550/R2/R5	50	0,15
Kupplungsstab-Bieger Pin Bender Outil à plier l'axe de jonction	<b>PB1</b>				0,5



\* leicht magnetisch / slightly magnetic / faiblement magnétique

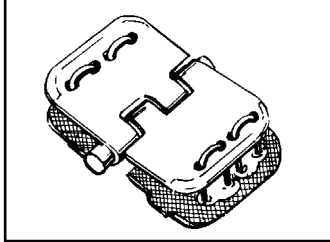

## ALLIGATOR Ready Set

Montagewerkzeuge  
und Zubehör

Installation Tools and  
Accessories

Outils de montage  
et accessoires



### RSTK-Werkzeugkoffer

mit RSC187-Gerät, Klammersetzplatte,  
Hammer, Rillenhobel, Bandoecken-  
trimmzange.

### RSTK-Staple Kit

with RSC187 Installation Tool, Staple  
Set Plate, Hammer, Hand Skiver,  
Belt Nippers.

### RSTK-Coffret d'outillage

avec appareil de montage RSC187,  
plaque de pose de crampons, marteau,  
rabot pour courroie, pince coupante.

Bestell-Nr.  
Order-No.  
No. de réf.

Gerät  
Tool  
Outil

Gewicht  
Weight  
Poids  
kg

**RSTK4-6**  
**RSTK4-12**

RSC187-6  
RSC187-12

8,8  
12,1

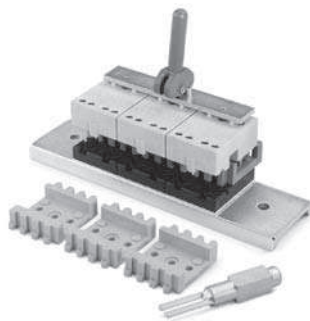

### Montagegeräte

### Staple Driving Tools

### Appareils de montage

Bestell-Nr.  
Order-No.  
No. de réf.

Breite  
Width  
Largeur  
mm

Gewicht  
Weight  
Poids  
kg

**RSC187**  
**RSC187-4**  
**RSC187-6**  
**RSC187-12**  
**RSC187-18**  
**RSC187-24**  
**RSC187-36**  
**RSC187-48**  
**RSC187-60**

50  
100  
150  
300  
450  
600  
900  
1200  
1500

0,5  
1,5  
3,0  
5,0  
7,5  
9,0  
14,0  
17,0  
25,0



### GOLD CLASS Montagegerät

### GOLD CLASS Installation Tool

### GOLD CLASS Appareil de montage

### RS-GOLD-DRIVER

**RS-GOLD-INITIAL-12/300**  
**RS-GOLD-INITIAL-24/600**  
**RS-GOLD-INITIAL-36/900**  
**RS-GOLD-INITIAL-48/1200**  
**RS-GOLD-FINAL-12/300**  
**RS-GOLD-FINAL-24/600**  
**RS-GOLD-FINAL-36/900**  
**RS-GOLD-FINAL-48/1200**

5,6  
4,8  
9,0  
11,5  
13,6  
4,9  
9,9  
12,3  
14,5

**ST7-5** Block schwarz / Guide Block black / Bloc de guidage noir  
**ST7-9** Stößel / Punch / Poinçon  
**ST7-29** Setzplatte / Wear Plate / Plaque de pose

0,3  
3,4  
1,1

### Pressbacken für hydraulische Maschinen

zum Umlegen der Klammerspitzen

**Press Plates for Hydraulic Lacers** to bend staple tips

### Mâchoires pour agrafeuses hydrauliques

pour plier les pointes des crampons

Für / for / pour

kg

**P2AS**  
**P6AS**

ARU 2000/3000  
AMK 400 / AMU 4000/6000





3,0  
5,0



Ersatzteile  
und Zubehör

Spare Parts and  
Accessories

Pièces de rechange et  
accessoires

		Bestell-Nr. Order-No. No. de réf.	Gewicht Weight Poids / kg
	Kupplungsstabschneider Hinge Pin Cutter Pince à couper les axes de jonction	<b>APC-1</b>	0,23
	Bandeckentrimmzange Belt Nippers Pince coupante	<b>BN-1</b>	0,36
	Rillenhobel Hand Skiver Rabot pour courroie	<b>RTBS-F</b>	0,06
	Bandschleifer Belt Grinder Meule pour bande	<b>RB-1</b>	0,34
	Bandmarkierstift Belt Marker Marqueur de bande	<b>M4</b>	0,01

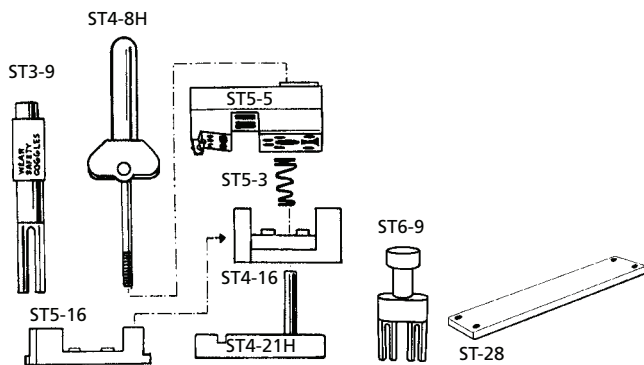

- ST3-9** Klammertreiber / Staple Driver / Chassoir de crampons  
**ST6-9** Klammertreiber / Staple Driver / Chassoir de crampons  
**ST4-8** Nockenhebel kurz für RSC187, RSC187-4, RS-Gold-Initial und RS-Gold-Final  
 Cam Lever Assembly short for RSC187, RSC187-4, RS-Gold-Initial and RS-Gold-Final  
 Levier de tension court pour RSC187, RSC187-4, RS-Gold-Initial et RS-Gold-Final  
**ST4-8H** Nockenhebel lang für RSC187-6 und breiter  
 Cam Lever Assembly long for RSC187-6  
 Levier de tension long pour RSC187-6  
**ST4-16** Kamm grün / Comb green / Peigne vert (125/187)  
**ST5-16** Kamm gelb / Comb yellow / Peigne jaune (62/125)  
**ST5-3** Druckfeder / Spring / Ressort de pression  
**ST5-5** Führungsblock für/ Guide Block for/ Bloc de guidage pour RS125MA / RS187MA  
**ST-28** Klammersetzplatte / Staple Set Plate / Plaque de pose de crampons  
**ST3-13** Schraube / Bolt / Vis  
**ST3-14** Fixierstift / Cam Locating Pin / Goupille  
**ST3-15-6** Klemmschiene / Clamp Bar / Rail de serrage  
**ST4-21** Amboßsegment kurz für RSC187 und RSC187-4  
 Anvil short for RSC187 and RSC187-4  
 Segment d'enclume court pour RSC187 et RSC187-4  
**ST4-21H** Amboßsegment / Anvil / Segment d'enclume  
**C150** Klammernmagazin für 125MA und 187 MA  
 Staple Dispenser for 125MA and 187 MA  
 Chargeur de crampons pour 125MA et 187 MA  
**ST4-5** Führungsblock grün für 125MA und 187MA  
 Guide Block green for 125MA and 187MA  
 Bloc de guidage vert pour 125MA et 187MA

**RSTK-Hammer**  
**RSTK-Koffer**

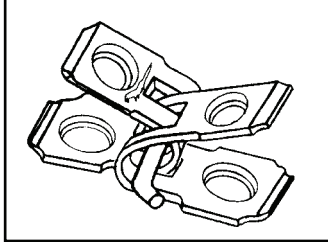

## ALLIGATOR Rivet

Transportband-  
Verbindungssystem für  
Rundballenpressen

Conveyor Belt Fastening  
System for Round Balers

Système d'agrafage pour  
bandes transporteuses  
pour presses à balles

Verbindergroße Fastener Size Taille des agrafes	Für Transportbänder bis zu... N/mm Festigkeit For Belts with a Tensile Strength of up to... N/mm Pour bandes tranporteuses à résistance de rupture jusqu'à... N/mm	empf. Bandstärkenbereich Belt Thickness Range Épaisseur de bandes recommandée mm	empf. kleinster Trommel-Ø rec. min. Pulley-Ø Ø tambour mini.rec. mm
<b>AR</b>	500	3,2 - 5,6	90

### Verbinder · Fasteners · Agrafes

Bestell-Nr. Order-No. No. de réf.	Bandbreite Belt Width Larg. de bande mm	Verbindungen Fastener Sets Jeux d'agrafes
<b>ARJ4/100</b>	100	2
<b>ARJ6/150</b>	150	2
<b>ARJ7/175</b>	175	2
<b>ARJ7/175-6STS</b>	175	6
<b>ARJ10/250</b>	250	2
<b>ARJ14/350</b>	350	2

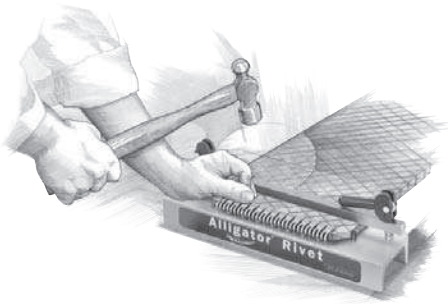

### Extra Kupplungsstäbe und Nieten Extra Hinge Pins and Rivets Axes et rivets supplémentaires

Bestell-Nr. Order-No. No. de réf.	Bandbreite Belt Width Larg. de bande mm	Inhalt Content Contenu
gehärteter Stahl, gerillt/steel corrugated, heat-treated/acier rainuré, trempé		
<b>ARSH4/100</b>	100	9
<b>ARSH6/150</b>	150	8
<b>ARSH7/175</b>	175	8
<b>ARSH10/250</b>	250	4
<b>ARSH14/350</b>	350	4
<b>AR3-15</b>	Nieten/Rivets	15

### Geräte · Tools · Outils

Bestell-Nr. Order-No. No. de réf.	Gerätebreite Tool Width Largeur d'outil mm
<b>ART-7</b>	175
<b>ART-10</b>	250
<b>ART-14</b>	350

#### ARTK-Gerätekoffer

mit ART-Gerät, Rillenhobel, Hammer, Kupplungsstababbieger und 2 Kartons ARJ-Verbindersets in einem Plastikkoffer

#### ARTK-Toolkit

includes ART Installation Tool, Hand Belt Skiver, Hammer, Pin Bender and 2 packages of ARJ fasteners in a plastic tool box

#### Coffret ARTK

Contenu: outil de pose, rabot pour courroie, marteau, outil pour plier les axes et 2 cartons de jeux d'agrafes ARJ dans un coffret plastique

Bestell-Nr. Order-No. No. de réf.	Gerätebreite Tool Width Largeur d'outil mm
<b>ARTK-7</b>	175
<b>ARTK-14</b>	350

#### MARTK-Gerätekoffer

mit MART Mehrfachnieten-Gerät, Führungsblock mit Schrauben, 2 Stück Druckluftschlaghammer, manuellem Stößel und Drucklufthammer in einem Plastikkoffer

#### MARTK-Toolkit

includes MART multiple rivet installation tool, guide block with screws, two pneumatic punches, hand punch and air hammer in a plastic tool box

#### Coffret MARTK

Contenu: outil de pose MART à rivets multiples, bloc de guidage avec vis, deux poinçons pneumatiques, poinçon manuel et marteau à air comprimé dans un coffret plastique

Bestell-Nr. Order-No. No. de réf.	Gerätebreite Tool Width Largeur d'outil mm
<b>MARTK-7</b>	175
<b>MARTK-14</b>	350

# ALLIGATOR Plastic Rivet

Plastikverbinder  
für Bandstärken  
von 1,6 - 3,2 mm

Plastic Rivet Fasteners  
for Belts  
1,6 - 3,2 mm thick

Agrafes plastiques pour  
bandes transporteuses  
d'épaisseur 1,6 - 3,2 mm

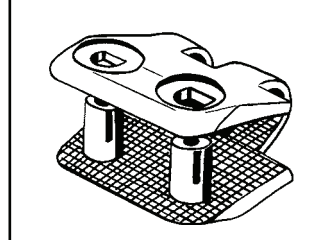

Verbindergröße Fastener Size Taille des agrafes	Für Transportbänder bis zu... N/mm Festigkeit For Belts with a Tensile Strength of up to... N/mm Pour bandes tranporteuses à résistance de rupture jusqu'à... N/mm	empf. Bandstärkenbereich Belt Thickness Range Épaisseur de bandes recommandée mm	empf. kleinster Trommel-Ø rec. min. Pulley-Ø Ø tambour mini.rec. mm
<b>APF100</b>	75	-2,4	40
<b>APF150</b>	100	1,6 - 3,2	75

## Plastikverbinder · Non metallic Fasteners · Agrafes plastiques

Bestell-Nr. Order-No. No. de réf.	Inhalt Content Contenu	Gewicht Weight Poids kg	Bestell-Nr. Order-No. No. de réf.	Inhalt Content Contenu	Gewicht Weight Poids kg
<b>APF 100W-100*</b>	100	0,29	<b>APF 150W-100*</b>	100	0,45
<b>APF 100W-500**</b>	500	0,61	<b>APF 150W-500**</b>	500	0,97
<b>APF 100B-100*</b>	100	0,29	<b>APF 150B-100*</b>	100	0,45
<b>APF 100B-500**</b>	500	0,61	<b>APF 150B-500**</b>	500	0,97
<b>APF 100BLUE-100*</b>	100	0,29	<b>APF 150BLUE-100*</b>	100	0,45

\* für Bandbreite 1200 mm mit Kupplungsdraht  
\* for belt width of 1200 mm with hinge material  
\* pour une épaisseur de bande de 1200 mm avec axe de jonction

\*\* ausreichend für 6 m Verbindung ohne Kupplungsdraht  
\*\* sufficient for 6 m splice without hinge material  
\*\* suffit pour 6 m de jonction sans axe de jonction

## Kupplungsdrähte · Hinge Material · Axes de jonction

Bestell-Nr. Order-No. No. de réf.	Länge Length Longueur m	Gewicht Weight Poids kg	Bestell-Nr. Order-No. No. de réf.	Länge Length Longueur m	Gewicht Weight Poids kg
<b>NK2,50</b>	30	0,20	<b>NK3,50</b>	30	0,40

## Montagegerät und Zubehör · Installation Tool and Accessories · Outils de montage et accessoires

Bestell-Nr. Order-No. No. de réf.	Gewicht Weight Poids kg	Bestell-Nr. Order-No. No. de réf.	Gewicht Weight Poids kg
<b>MDT220-1</b>	15,90	<b>PRL4</b>	0,17
<b>PCA7-600</b>	4,08		

## Bohrschablonen · Templets · Gabarits

<b>100T-600</b>	0,63	<b>150T-600</b>	0,57
<b>100T-1200</b>	1,13	<b>150T-1200</b>	1,08

## Locheisen · Belt Punch · Poinçon

<b>A100P</b>	0,03	<b>A150P</b>	0,03
--------------	------	--------------	------

## Nietkopf · Curling Bit · Tête de pose

<b>S100B</b>	0,03	<b>S150B</b>	0,03
--------------	------	--------------	------

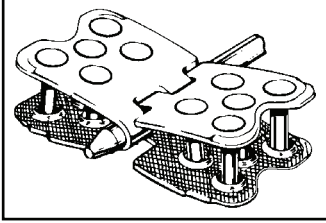

## FLEXCO Rivet Hinged

Transportband -  
Verbindungssystem  
für Bandstärken  
von 5 bis 17 mm

Conveyor Belt Fastening  
System for Belts  
5 to 17 mm thick

Système d'agrafage pour  
bandes transporteuses  
d'épaisseur 5 - 17 mm

Verbindergroße Fastener Size Taille des agrafes	Für Transportbänder bis zu... N/mm Festigkeit For Belts with a Tensile Strength of up to... N/mm Pour bandes transporteuses à résistance de rupture jusqu'à... N/mm	empf. Bandstärkenbereich Belt Thickness Range Épaisseur de bande recommandée mm	empf. kleinster Trommel-Ø rec. min. Pulley-Ø Ø tambour mini.rec. mm
<b>R2</b>	400	5 - 10	125
<b>R5</b>	800	6 - 11	175

**Inhalt:** Jeder Karton enthält 2 Verbinderstreifen für die angegebene Bandbreite. **Nieten und Kupplungsstäbe extra bestellen.**

**Hinweis:** Montagewerkzeug erforderlich (Seite 16)

**Content:** Each Box contains two Fastener Strips for the Belt Width specified. **Order Rivets and Hinge Pins separately.**

**Note:** Installation tool required (page 16)

**Contenu:** Chaque boîte contient deux bandes d'agrafes pour la largeur de bande spécifiée. **Veillez commander rivets et axes séparément.**

**Note:** Outil de montage nécessaire (page 16)

### Stahl verzinkt / Galvanized Steel / Acier galvanisé

Bestell-Nr. Order-No. No. de réf.	Bandbreite Belt Width Largeur de Bande mm	Gewicht Weight Poids kg
<b>R2-20/500</b>	500	0,75
<b>R2-26/650</b>	650	0,97
<b>R2-32/800</b>	800	1,20
<b>R2-40/1000</b>	1000	1,50
<b>R2-48/1200</b>	1200	1,80
<b>R2-55/1400</b>	1400	2,00

### Rostfrei W.1.4401 / Stainless AISI 316 / Inoxydable Z6CND17-11

Bestell-Nr. Order-No. No. de réf.	Bandbreite Belt Width Largeur de Bande mm	Gewicht Weight Poids kg
<b>R2S-20/500</b>	500	0,75
<b>R2S-26/650</b>	650	0,97
<b>R2S-32/800</b>	800	1,20
<b>R2S-40/1000</b>	1000	1,50
<b>R2S-48/1200</b>	1200	1,80

### J-Karton / J-Carton / Boîte J

**Inhalt:** Jeder J-Karton enthält eine komplette Verbindung mit Nieten und NC-Kupplungsstab

**Content:** Each J-Box contains one complete splice with rivets and NC-hinge pin

**Contenu:** Chaque boîte J contient une jonction complète avec rivets et axe NC

Bestell-Nr. Order-No. No. de réf.	Bandbreite Belt Width Largeur de Bande mm	Gewicht Weight Poids kg
<b>R2MA</b>	10 × 170 mm	1,4
<b>R5MA-SE</b>	10 × 170 mm	2,2
<b>R5-1/2MA-SE</b>	10 × 170 mm	2,8

### MegAlloy

Bestell-Nr. Order-No. No. de réf.	Inhalt Content Contenu	Gewicht Weight Poids kg
<b>R2MA</b>	10 × 170 mm	1,4
<b>R5MA-SE</b>	10 × 170 mm	2,2
<b>R5-1/2MA-SE</b>	10 × 170 mm	2,8

Bandstärkenbereich / Belt Thickness Range / Épaisseur de bande recommandée: **5 - 7 mm**

<b>R2J-20/500AANC</b>	500	0,75
<b>R2J-26/650AANC</b>	650	0,97
<b>R2J-32/800AANC</b>	800	1,20
<b>R2J-40/1000AANC</b>	1000	1,50
<b>R2J-48/1200AANC</b>	1200	1,80

Bandstärkenbereich / Belt Thickness Range / Épaisseur de bande recommandée: **7 - 10 mm**

<b>R2J-20/500ANC</b>	500	0,75
<b>R2J-26/650ANC</b>	650	0,97
<b>R2J-32/800ANC</b>	800	1,20
<b>R2J-40/1000ANC</b>	1000	1,50
<b>R2J-48/1200ANC</b>	1200	1,80

Bandstärkenbereich / Belt Thickness Range / Épaisseur de bande recommandée: **7 - 11 mm**

<b>R5J-SE-20/500NC</b>	500	1,27
<b>R5J-SE-26/650NC</b>	650	1,66
<b>R5J-SE-32/800NC</b>	800	2,20
<b>R5J-SE-40/1000NC</b>	1000	2,54
<b>R5J-SE-48/1200NC</b>	1200	3,13

Verbindergroße Fastener Size Taille des agrafes	Für Transportbänder bis zu... N/mm Festigkeit For Belts with a Tensile Strength of up to... N/mm Pour bandes transporteuses à résistance de rupture jusqu'à... N/mm	empf. Bandstärkenbereich Belt Thickness Range Épaisseur de bande recommandée mm	empf. kleinster Trommel-Ø rec. min. Pulley-Ø Ø tambour mini.rec. mm
<b>R5</b>	800	6 - 11	175
<b>R5<sup>1/2</sup></b>	1250	8 - 15	250
<b>R6 / RAR6</b>	1400 / 1600	10 - 17	400
<b>R8 / RAR8</b>	2000 / 2500	10 - 17	400
<b>R9S</b>	3500	16 - 25	1050

**Inhalt:** Jeder Karton enthält 2 Verbinderstreifen für die angegebene Bandbreite. **Nieten und Kupplungsstäbe extra bestellen.**

**Content:** Each Box contains two Fastener Strips for the Belt Width specified. **Order Rivets and Hinge Pins separately.**

**Contenu:** Chaque boîte contient deux bandes d'agrafes pour la largeur de bande spécifiée. **Veillez commander rivets et axes séparément.**

### Stahl verzinkt / Galvanized Steel / Acier galvanisé

Bestell-Nr. Order-No. No. de réf.	Bandbreite Belt Width Largeur de Bande mm	Gewicht Weight Poids kg
<b>R5-SE-20/500</b>	500	1,27
<b>R5-SE-26/650</b>	650	1,66
<b>R5-SE-32/800</b>	800	2,20
<b>R5-SE-40/1000</b>	1000	2,54
<b>R5-SE-48/1200</b>	1200	3,13
<b>R5-SE-55/1400</b>	1400	3,56
<b>R5-SE-63/1600</b>	1600	4,10
<b>R5-<sup>1/2</sup>-SE-26/650</b>	650	2,40
<b>R5-<sup>1/2</sup>-SE-32/800</b>	800	2,95
<b>R5-<sup>1/2</sup>-SE-40/1000</b>	1000	3,68
<b>R5-<sup>1/2</sup>-SE-48/1200</b>	1200	4,49
<b>R5-<sup>1/2</sup>-SE-55/1400</b>	1400	5,16
<b>R5-<sup>1/2</sup>-SE-63/1600</b>	1600	5,89
<b>R5-<sup>1/2</sup>-SE-72/1800</b>	1800	6,63
<b>R6-SE-32/800</b>	800	4,00
<b>R6-SE-40/1000</b>	1000	5,00
<b>R6-SE-48/1200</b>	1200	6,00
<b>R6-SE-55/1400</b>	1400	7,00
<b>R6-SE-63/1600</b>	1600	8,00
<b>R6-SE-72/1800</b>	1800	9,00
<b>R8-SE-40/1000</b>	1000	5,00
<b>R8-SE-48/1200</b>	1200	6,00
<b>R8-SE-55/1400</b>	1400	7,00
<b>R8-SE-63/1600</b>	1600	8,00
<b>R8-SE-72/1800</b>	1800	9,00

### RustAlloy - W.1.4016 / AISI 430 / Z8C17 magnetisch / magnetic / magnétique

Bestell-Nr. Order-No. No. de réf.	Bandbreite Belt Width Largeur de Bande mm	Gewicht Weight Poids kg
<b>RAR5-SE-26/650</b>	650	1,66
<b>RAR5-SE-32/800</b>	800	2,20
<b>RAR5-SE-40/1000</b>	1000	2,54
<b>RAR5-SE-48/1200</b>	1200	3,13
<b>RAR5-SE-55/1400</b>	1400	3,56
<b>RAR5-SE-63/1600</b>	1600	4,10
<b>RAR5-<sup>1/2</sup>-SE-26/650</b>	650	2,40
<b>RAR5-<sup>1/2</sup>-SE-32/800</b>	800	2,95
<b>RAR5-<sup>1/2</sup>-SE-40/1000</b>	1000	3,68
<b>RAR5-<sup>1/2</sup>-SE-48/1200</b>	1200	4,49
<b>RAR5-<sup>1/2</sup>-SE-55/1400</b>	1400	5,16
<b>RAR5-<sup>1/2</sup>-SE-63/1600</b>	1600	5,89
<b>RAR5-<sup>1/2</sup>-SE-72/1800</b>	1800	6,63
<b>RAR6-SE-32/800</b>	800	4,00
<b>RAR6-SE-40/1000</b>	1000	5,00
<b>RAR6-SE-48/1200</b>	1200	6,00
<b>RAR6-SE-55/1400</b>	1400	7,00
<b>RAR6-SE-63/1600</b>	1600	8,00
<b>RAR6-SE-72/1800</b>	1800	9,00
<b>RAR8-SE-40/1000</b>	1000	5,00
<b>RAR8-SE-48/1200</b>	1200	6,00
<b>RAR8-SE-55/1400</b>	1400	7,00
<b>RAR8-SE-63/1600</b>	1600	8,00
<b>RAR8-SE-72/1800</b>	1800	9,00

### Rostfrei W.1.4401 / Stainless AISI 316 / Inoxydable Z6CND17-11

Bestell-Nr. Order-No. No. de réf.	Bandbreite Belt Width Largeur de Bande mm	Gewicht Weight Poids kg	Bestell-Nr. Order-No. No. de réf.	Bandbreite Belt Width Largeur de Bande mm	Gewicht Weight Poids kg
<b>R5S-SE-20/500</b>	500	1,27	<b>R9S-SE-40/1000</b>	1000	6,50
<b>R5S-SE-26/650</b>	650	1,66	<b>R9S-SE-48/1200</b>	1200	7,70
<b>R5S-SE-32/800</b>	800	2,20	<b>R9S-SE-55/1400</b>	1400	9,00
<b>R5S-SE-40/1000</b>	1000	2,54	<b>R9S-SE-63/1600</b>	1600	10,00
<b>R5S-SE-48/1200</b>	1200	3,13	<b>R9S-SE-72/1800</b>	1800	11,50
<b>R5S-SE-55/1400</b>	1400	3,56			
<b>R5S-SE-63/1600</b>	1600	4,10			



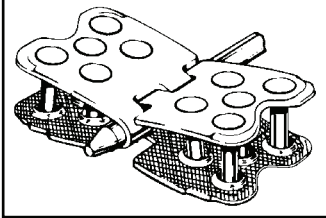

## FLEXCO Rivet Hinged

Kupplungsstäbe

Hinge Pins

Axes de jonction

### Stahl / Steel / Acier

Bestell-Nr. Order-No. No. de réf.	Ø mm	Verbinder Fasteners Agrafes	Bandbreite Belt Width Largeur de bande mm
<b>NC-500-1</b>	6,3	R2, R5, 375, 550	500
<b>NC-650-1</b>			650
<b>NC-800-1</b>			800
<b>NC-1000-1</b>			1000
<b>NC-1200-1</b>			1200
<b>NC-1400-1</b>			1400
<b>NC-1600-1</b>			1600
<b>NC-C</b>			Rolle / Coil / Rouleau 30 m
Kupplungsstab-Sicherungsscheiben / Hinge Pin Retaining Washers / Rondelles de butée pour axes de jonction			
<b>310-RET-50</b>		NC / NCS	
<b>SC-500-1</b>	6,0	R2, R5, 375, 550	500
<b>SC-650-1</b>			650
<b>SC-800-1</b>			800
<b>SC-1000-1</b>			1000
<b>SC-1200-1</b>			1200
<b>SC-C</b>			Rolle / Coil / Rouleau 30 m
<b>AC-500-1</b>	6,3	R2, R5, 375, 550	500
<b>AC-650-1</b>			650
<b>AC-800-1</b>			800
<b>AC-1000-1</b>			1000
<b>AC-1200-1</b>			1200
<b>AC-1400-1</b>			1400
<b>AC-1600-1</b>			1600
<b>AC-3000-1</b>			3000
<b>NAC-500-1</b>	6,3	R2, R5, 375, 550	500
<b>NAC-650-1</b>			650
<b>NAC-800-1</b>			800
<b>NAC-1000-1</b>			1000
<b>NAC-1200-1</b>			1200
<b>NAC-1400-1</b>			1400
<b>NAC-1600-1</b>	1600		
<b>AC6-650-1</b>	9,6	R5-1/2, R6, R8	650
<b>AC6-800-1</b>			800
<b>AC6-1000-1</b>			1000
<b>AC6-1200-1</b>			1200
<b>AC6-1400-1</b>			1400
<b>AC6-1600-1</b>			1600
<b>AC6-1800-1</b>			1800
<b>NAC6-800-1</b>			10,3
<b>NAC6-1000-1</b>	1000		
<b>NAC6-1200-1</b>	1200		
<b>NAC6-1400-1</b>	1400		
<b>NAC6-1600-1</b>	1600		
<b>NAC6-1800-1</b>	1800		
<b>SC6-650-1</b>	8,8	R5-1/2, R6, R8	650
<b>SC6-800-1</b>			800
<b>SC6-1000-1</b>			1000
<b>SC6-1200-1</b>			1200
<b>SC6-1400-1</b>			1400
<b>SC6-1600-1</b>			1600

### Rostfrei / Stainless / Inoxydable

Bestell-Nr. Order-No. No. de réf.	Ø mm	Verbinder Fasteners Agrafes	Bandbreite Belt Width Largeur de bande mm
<b>NCS-500-1</b>	6,3	R2, R5, 375, 550	500
<b>NCS-650-1</b>			650
<b>NCS-800-1</b>			800
<b>NCS-1000-1</b>			1000
<b>NCS-1200-1</b>			1200
<b>NCS-1400-1</b>			1400
<b>NCS-1600-1</b>			1600
<b>NCS-C</b>			Rolle / Coil / Rouleau 30 m
<b>SSC-500-1</b>	6,0	R2, R5, 375, 550	500
<b>SSC-650-1</b>			650
<b>SSC-800-1</b>			800
<b>SSC-1000-1</b>			1000
<b>SSC-1200-1</b>			1200
<b>ACS-500-1</b>	6,3	R2, R5, 375, 550	500
<b>ACS-650-1</b>			650
<b>ACS-800-1</b>			800
<b>ACS-1000-1</b>			1000
<b>ACS-1200-1</b>			1200
<b>ACS-1400-1</b>			1400
<b>ACS-1600-1</b>			1600
<b>ACS-3000-1</b>			3000
<b>ACS6-650-1</b>	9,6	R5-1/2, R6, R8	650
<b>ACS6-800-1</b>			800
<b>ACS6-1000-1</b>			1000
<b>ACS6-1200-1</b>			1200
<b>ACS6-1400-1</b>			1400
<b>ACS6-1600-1</b>			1600
<b>ACS6-1800-1</b>	1800		
<b>NCS962-1200-1</b>		R9	1200
<b>NCS962-1400-1</b>			1400
<b>NCS962-1600-1</b>			1600
<b>NCS962-1800-1</b>			1800
<b>NCS975-1200-1</b>		R9	1200
<b>NCS975-1400-1</b>			1400
<b>NCS975-1600-1</b>			1600
<b>NCS975-1800-1</b>			1800
<b>Antimagnetisch / Non magnetic</b>			
<b>Anti-magnétique</b>			
<b>NB-500-1</b>	6,3	R2, R5, 375, 550	500
<b>NB-650-1</b>			650
<b>NB-800-1</b>			800
<b>NB-1000-1</b>			1000
<b>NB-1200-1</b>			1200
<b>NB-C</b>			Rolle / Coil / Rouleau 30 m

**Nieten Auswahltabelle**  
**Rivet Selection Chart**  
**Tableau de selection des rivets**

Verbinder Fasteners Agrafes	Bandstärke Belt Thickness Epaisseur de bande	Größe Size Largeur
<b>R2</b>	5 - 6	<b>SRAA</b>
	6 - 8	<b>SRA</b>
	7 - 10	<b>SRB</b>
<b>R5</b>	6 - 8	<b>SRA</b>
	7 - 10	<b>SRB</b>
	9 - 11	<b>SRC</b>
<b>R5-1/2</b>	8 - 9	<b>SRB</b>
	9 - 10,5	<b>SRC</b>
	10 - 12	<b>SRC/D</b>
	11 - 13,5	<b>SRD</b>
	13 - 15	<b>SRE</b>
<b>R6 / R8</b>	9 - 11	<b>SRC/D</b>
	10,5 - 13	<b>SRD</b>
	12 - 14	<b>SRE</b>
	13,5 - 16	<b>SRF</b>
	15 - 17	<b>SRG</b>
<b>R9S</b>	16,5 - 19	<b>SRH</b>
	18 - 21	<b>SRI</b>
	20 - 22	<b>SRJ</b>
	21 - 24	<b>SRK</b>

Bei Bändern mit weichen Decken verwenden Sie bitte die nächstkleinere Nietengröße.

We recommend to use the next smaller rivet size for belts with soft covers.

Nous recommandons d'utiliser une taille de rivets inférieure pour des bandes souples.

**FLEXCO Rapid Loader-Nieten · Rivets · Rivets**

Inhalt 60 Streifen / 1200 Niete pro Eimer  
 Content 60 strips / 1200 rivets per bucket  
 Contenu 60 bandes / 1200 rivets par seau

Bestell-Nr. Order-No. No. de réf.	Größe Size Taille	Farbe Colour Couleur	Gewicht Weight Poids kg
---	-------------------------	----------------------------	----------------------------------

**Stahl / Steel / Acier**

<b>CSRLA</b>	A	Rot/Red/Rouge	5,89
<b>CSRLB</b>	B	Weiß/White/Blanc	6,31
<b>CSRLC</b>	C	Blau/Blue/Bleu	6,72
<b>CSRLC/D</b>	C/D	Orange	7,05
<b>CSRLD</b>	D	Grün/Green/Vert	7,28
<b>CSRLE</b>	E	Lila/Purple/Lilas	7,53
<b>CSRLF</b>	F	Gelb/Yellow/Jaune	7,86
<b>CSRLG</b>	G	Schwarz/Black/Noir	8,11

**Rostfrei / Stainless / Inoxydable**

<b>CSRLA-S</b>	A	Rot/Red/Rouge	5,84
<b>CSRLB-S</b>	B	Weiß/White/Blanc	6,25
<b>CSRLC-S</b>	C	Blau/Blue/Bleu	6,76
<b>CSRLC/D-S</b>	C/D	Orange	6,94
<b>CSRLD-S</b>	D	Grün/Green/Vert	7,21
<b>CSRLE-S</b>	E	Lila/Purple/Lilas	7,47
<b>CSRLF-S</b>	F	Gelb/Yellow/Jaune	7,67
<b>CSRLG-S</b>	G	Schwarz/Black/Noir	7,94

**Nieten pro Verbindung**  
**Rivets per Splice**  
**Rivets par jonction**

Bandbreite Belt Width Largeur de bande	Platten Plates Plaques	R2	R5, 5-1/2, R6	R8/R9S
400	9	36	90	
500	11	44	110	
650	14	56	140	
800	18	72	180	
1000	22	88	220	352
1200	27	108	270	432
1400	31	124	310	496
1600	36	144	360	576
1800	41	164	410	656

**FLEXCO-Nieten · Rivets · Rivets**

Bestell-Nr. Order-No. No. de réf.	Größe Size Largeur	Inhalt Content Contenu	Gewicht Weight Poids kg
<b>Stahl / Steel / Acier</b>			
<b>SRAA</b>	SRAA	250	1,00
<b>SRA</b>	SRA	250	1,04
<b>SRB</b>	SRB	250	1,13
<b>SRC</b>	SRC	250	1,18
<b>SRC/D</b>	SRC/D	250	1,27
<b>SRD</b>	SRD	250	1,32
<b>SRE</b>	SRE	250	1,41
<b>SRF</b>	SRF	250	1,41
<b>SRG</b>	SRG	250	1,45
<b>SRH</b>	SRH	250	1,54
<b>SRI</b>	SRI	250	1,65
<b>SRJ</b>	SRJ	250	1,73
<b>SRK</b>	SRK	250	1,85

<b>SRAA-2M</b>	SRAA	2000	7,52
<b>SRA-2M</b>	SRA	2000	7,52
<b>SRB-2M</b>	SRB	2000	8,20
<b>SRC-2M</b>	SRC	2000	9,15
<b>SRC/D-2M</b>	SRC/D	2000	9,60
<b>SRD-2M</b>	SRD	2000	9,92
<b>SRE-2M</b>	SRE	2000	10,46
<b>SRF-2M</b>	SRF	2000	11,05
<b>SRG-2M</b>	SRG	2000	11,28

**Rostfrei W.1.4016 / magnetisch**  
**Stainless AISI 430 / magnetic**  
**Inoxydable Z8C17 / magnétique**

<b>SRAA-S</b>	SRAA	250	1,00
<b>SRA-S</b>	SRA	250	1,04
<b>SRB-S</b>	SRB	250	1,13
<b>SRC-S</b>	SRC	250	1,18
<b>SRC/D-S</b>	SRC/D	250	1,27
<b>SRD-S</b>	SRD	250	1,32
<b>SRE-S</b>	SRE	250	1,41
<b>SRF-S</b>	SRF	250	1,41
<b>SRG-S</b>	SRG	250	1,45

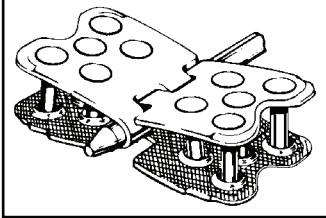

## FLEXCO Rivet Hinged

Montagegeräte

Installation Tools

Outils de montage

Bestell-Nr. Order-No. No. de réf.	Breite Width Largeur mm	Gewicht Weight Poids kg
<b>R2T</b>	300	3,00
<b>SRTA-12D-AL</b>	300	7,00
<b>SRTA-24D-AL</b>	600	12,00
<b>SRTA-36D-AL</b>	900	17,00
<b>MSRTX-30</b>	750	23,00
<b>MSRTX-36</b>	900	25,00
<b>MSRTX-42</b>	1050	27,00
<b>MSRTX-48</b>	1200	29,00
<b>MSRTX-60</b>	1500	31,00
<b>MSRTX-12-AL</b>	300	10,00
<b>MSRTX-30-AL</b>	750	21,00
<b>MSRTX-36-AL</b>	900	22,50
<b>MSRTX-42-AL</b>	1050	24,00
<b>MSRTX-48-AL</b>	1200	26,00
<b>MSRTX-60-AL</b>	1500	28,00
<b>MSRT-30E-AL*</b>	750	35,00
<b>MSRT-36E-AL*</b>	900	40,00
<b>MSRT-42E-AL*</b>	1050	45,00
<b>MSRT-48E-AL*</b>	1200	49,00
<b>MSRT-60E-AL*</b>	1500	65,00
<b>MSRT-72-AL</b>	1800	47,00
<b>MSRT8-48</b>	1200	38,50
<b>MSRT8-60</b>	1500	42,00
<b>MSRT8-72</b>	1800	46,00
<b>MSRT8-84</b>	2100	50,00
<b>MSRT8-48E*</b>	1200	54,00
<b>MSRT8-60E*</b>	1500	69,00
<b>MSRT8-48-AL</b>	1200	35,00
<b>MSRT8-60-AL</b>	1500	38,00
<b>MSRT8-72-AL</b>	1800	42,00
<b>MSRT8-84-AL</b>	2100	45,00
<b>MSRT8-48E-AL*</b>	1200	60,00
<b>MSRT8-60E-AL*</b>	1500	65,00
<b>MSRT9-48</b>	1200	40,00
<b>MSRT9-60</b>	1500	42,00
<b>MSRT9-72</b>	1800	45,00
<b>MSRT9-84</b>	2100	50,00

\*mit Metallkoffer / with Tool Box / avec coffret métallique

### Montagegeräte / Installation Tools / Outils de montage

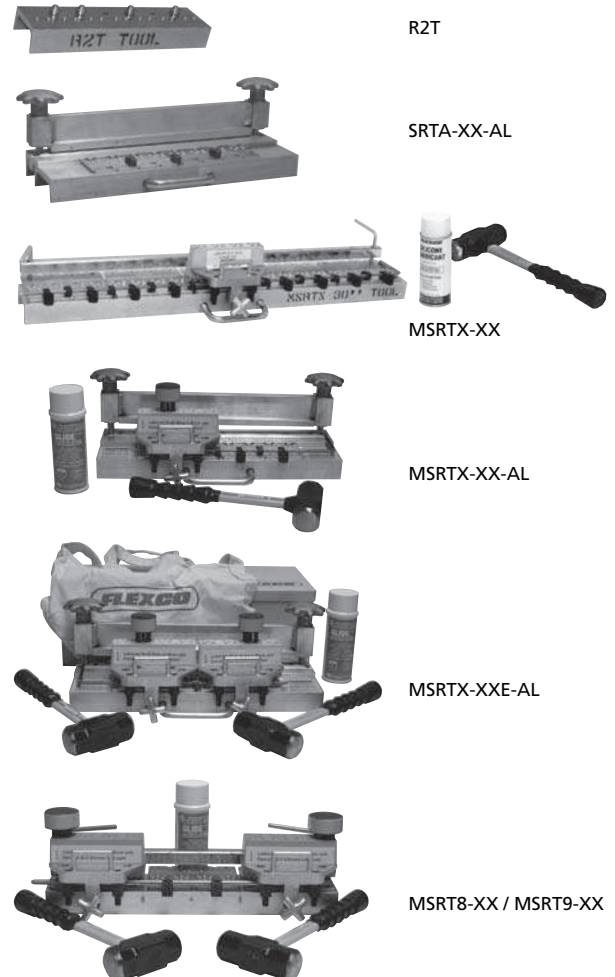

**Schlaghammer BOSCH**  
**Demolition Hammer BOSCH**  
**Marteau électrique BOSCH**  
**GSH5E**



**Nietentreiber für Bosch-Schlaghammer**  
**Drive Rod for Bosch Demolition Hammer**  
**Chassoir à rivets pour marteau électrique Bosch**  
**EPRD-DR**



Ersatzteile  
und Zubehör

Spare Parts and  
Accessories

Pièces de rechange  
et accessoires

Bestell-Nr. Order-No. No. de réf.		Gewicht Weight Poids kg
<b>SR700</b>	Führungsblock / Guide Block R5, R 5½, R6	1,36
<b>SR800</b>	Führungsblock / Guide Block R8, R9S	1,36
<b>SR759</b>	Nietentreiber / Drive Rod R5, R 5½, R6	0,44
<b>SR759-2</b>	Nietentreiber / Drive Rod R2	0,40
<b>SR859-8</b>	Nietentreiber / Drive Rod R8, R9S	0,50
<b>4FH</b>	Hammer / Hammer	2,00
<b>SL5-1</b>	Silikonspray / Silicone Spray	0,62
<b>SR50</b>	Einzelnietentreiber komplett Individual Drive Rod complete	0,35
<b>SR5-7</b>	Treiberstift / Drive Pin	0,03
<b>SR-CB</b>	Kanvastasche / Canvas Bag	0,60
<b>R5-RAR6LP</b>	Lehre zur Nietenauswahl / Rivet Gauge	
<b>R6-R8</b>	Lehre zur Nietenauswahl / Rivet Gauge	

SR759 (R5 / R5½ / R6) SR700 (R5 / R5½ / R6)  
SR759-2 (R2)

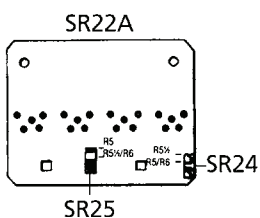
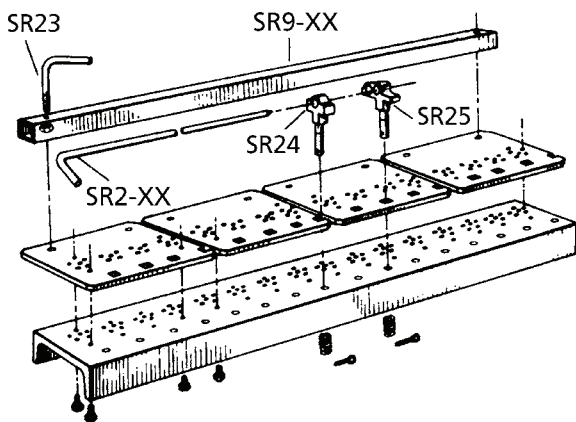
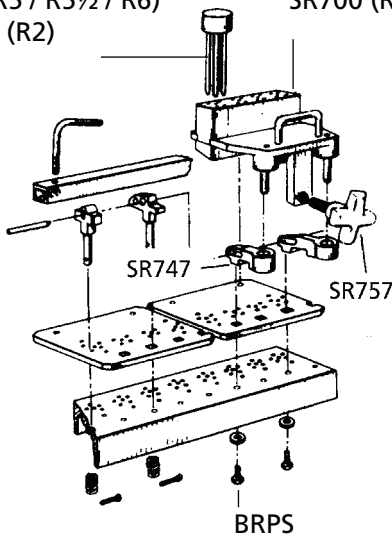

R5-RAR6LP Rivet Gauge  
R6-R8 Rivet Gauge

Bestell-Nr. Order-No. No. de réf.		Gewicht Weight Poids kg
---	--	----------------------------------

**Ersatzteile für MSRT / Spare Parts for MSRT**

<b>SR23</b>	Fixierschraube / Tightening Bolt	0,10
<b>SR24</b>	Halterung / Gauge Pin Guide	0,04
<b>SR25</b>	Halterung / Gauge Pin Guide	0,04
<b>SR22SA</b>	Amboßplatte / Anvil Plate MSRT	0,80
<b>SR27SA</b>	Amboßplatte / Anvil Plate MSRT8	0,80
<b>SR747</b>	Nietenführungseinheit Rivet Guide Locator Assembly	0,10
<b>SR757</b>	Fixierschraube / Clamping Screw	0,25
<b>BRPS</b>	Schrauben / Screws (50)	0,31
<b>SR5-1</b>	Schraubhülsen 2er-Set / Collets Set of 2	0,04
<b>R5J-RS</b>	Einzelnietensetzer / Single Rivet Set Tool	0,04

**Steckstift für / Gauge Pin for**

<b>SR2-30</b>	MSRT-30 / MSRTX-30
<b>SR2-36</b>	MSRT-36 / MSRTX-36
<b>SR2-42</b>	MSRT-42 / MSRTX-42
<b>SR2-48</b>	MSRT-48 / MSRTX-48
<b>SR2-60</b>	MSRT-60 / MSRTX-60
<b>SR2-72</b>	MSRT-72 / MSRTX-72
<b>SR2-84</b>	MSRT-84 / MSRTX-84

**Klemmschiene für / Clamp Bar for**

<b>SR9-30</b>	MSRT-30 / MSRTX-30
<b>SR9-36</b>	MSRT-36 / MSRTX-36
<b>SR9-42</b>	MSRT-42 / MSRTX-42
<b>SR9-48</b>	MSRT-48 / MSRTX-48
<b>SR9-60</b>	MSRT-60 / MSRTX-60
<b>SR9-72</b>	MSRT-72 / MSRTX-72
<b>SR9-84</b>	MSRT-84 / MSRTX-84

**Ersatzteile für MSRT-AL / Spare Parts for MSRT-AL**

<b>SR22-AL</b>	Amboßplatte / Anvil Plate MSRT-AL	0,10
<b>SR23-AL</b>	Fixierschraube / Tightening Bolt	0,10
<b>SR24-AL</b>	Halterung / Gauge Pin Guide	0,04
<b>SR25-AL</b>	Halterung / Gauge Pin Guide	0,04
<b>SR27-AL</b>	Amboßplatte / Anvil Plate MSRT8-AL	0,80
<b>SR747-AL</b>	Nietenführungseinheit Rivet Guide Locator Assembly	0,10
<b>SR757</b>	Fixierschraube / Clamping Screw	0,25
<b>SRPS-AL</b>	Schrauben / Screws (50)	0,31

**Steckstift für / Gauge Pin for**

<b>SR2-30-AL</b>	MSRT-30 / MSRTX-30
<b>SR2-36-AL</b>	MSRT-36 / MSRTX-36
<b>SR2-42-AL</b>	MSRT-42 / MSRTX-42
<b>SR2-48-AL</b>	MSRT-48 / MSRTX-48
<b>SR2-60-AL</b>	MSRT-60 / MSRTX-60
<b>SR2-72-AL</b>	MSRT-72 / MSRTX-72
<b>SR2-84-AL</b>	MSRT-84 / MSRTX-84

**Klemmschiene für / Clamp Bar for**

<b>SR9-30-AL</b>	MSRT-30 / MSRTX-30
<b>SR9-36-AL</b>	MSRT-36 / MSRTX-36
<b>SR9-42-AL</b>	MSRT-42 / MSRTX-42
<b>SR9-48-AL</b>	MSRT-48 / MSRTX-48
<b>SR9-60-AL</b>	MSRT-60 / MSRTX-60
<b>SR9-72-AL</b>	MSRT-72 / MSRTX-72
<b>SR9-84-AL</b>	MSRT-84 / MSRTX-84

**SR91-AL** Klemmschienenmutter mit Schrauben  
Clamp Bar Nut with Screws

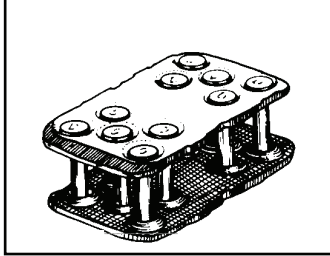

## FLECO Rivet Solid Plate

Transportband -  
Verbindungssystem  
für Bandstärken  
von 6 bis 24 mm

Conveyor Belt  
Fastening System  
for Belts 6 to 24 mm  
thick

Système d'agrafage  
pour bandes  
transporteuses  
d'épaisseur 6 - 24 mm

Verbindergroße Fastener Size Taille des agrafes	Inhalt Content Contenu	Für Transportbänder bis zu... N/mm Festigkeit For Belts with a Tensile Strength of up to... N/mm Pour bandes transporteuses à résistance de rupture jusqu'à... N/mm	empf. Bandstärkenbereich Belt Thickness Range Épaisseur de bande recommandée mm	empf. kleinster Trommel-Ø rec. min. Pulley-Ø Ø tambour mini.rec. mm
<b>BR-6</b>		630	6 - 17	350
<b>BR-10</b>	1,5 m	1250	6 - 17	450
<b>BR-14</b>	1,5 m	1600	10 - 24	900

### Verbinder · Fasteners · Agrafes

#### Stahl verzinkt Galvanized Steel / Acier galvanisé

Bestell-Nr. Order-No. No. de réf.	Bandbreite Belt Width Largeur de Bande mm	Gewicht Weight Poids kg
<b>BR6-SE-500*</b>	500	1,80
<b>BR6-SE-650*</b>	650	2,30
<b>BR6-SE-800*</b>	800	2,80
<b>BR6-SE-1000*</b>	1000	3,20
<b>BR6-SE-1200*</b>	1200	3,60

#### Rostfrei W.1.4401 / Stainless AISI 316 / Inoxydable Z6CND17-11

Bestell-Nr. Order-No. No. de réf.	Bandbreite Belt Width Largeur de Bande mm	Gewicht Weight Poids kg
<b>BR6S-SE-500*</b>	500	1,80
<b>BR6S-SE-650*</b>	650	2,30
<b>BR6S-SE-800*</b>	800	2,80
<b>BR6S-SE-1000*</b>	1000	3,20
<b>BR6S-SE-1200*</b>	1200	3,60

\* Jeder Karton enthält 2 komplette Verbindungen für die angegebene Bandbreite.

Each Box contains 2 complete Fastener Sets for the Belt Width specified.

Chaque boîte contient 2 jeux complets de jonction pour la largeur de bande spécifiée.

Bestell-Nr. Order-No. No. de réf.	Material Material Matériel	Inhalt Content Contenu m	Gewicht Weight Poids kg
<b>BR-10-SE</b>	Stahl · Steel	1,5	3,63
<b>BR-14</b>	Acier	1,5	5,86
<b>BR-10MA-SE</b>	MegAlloy	1,5	3,63
<b>BR-14MA</b>		1,5	5,86
<b>BR-10S-SE</b>	Rostfrei · Stainless Inoxydable	1,5	3,63

### FLECO Rapid Loader-Nieten · Rivets · Rivets BR6

Inhalt 32 Streifen / 786 Nieten pro Eimer  
Content 32 strips / 786 rivets per bucket  
Contenu 32 bandes / 786 rivets par seau

Bestell-Nr. Order-No. No. de réf.	Größe Size Taille	Farbe Colour Couleur	Gewicht Weight Poids kg
---	-------------------------	----------------------------	----------------------------------

#### Stahl / Steel / Acier

<b>CBR6A</b>	A	Rot/Red/Rouge	4,75
<b>CBR6B</b>	B	Weiß/White/Blanc	5,00
<b>CBR6C</b>	C	Blau/Blue/Bleu	5,25
<b>CBR6C/D</b>	C/D	Orange	5,50
<b>CBR6D</b>	D	Grün/Green/Vert	5,75
<b>CBR6E</b>	E	Lila/Purple/Lilas	6,00

#### Rostfrei / Stainless / Inoxydable

<b>CBR6A-S</b>	A	Rot/Red/Rouge	4,75
<b>CBR6B-S</b>	B	Weiß/White/Blanc	5,00
<b>CBR6C-S</b>	C	Blau/Blue/Bleu	5,25
<b>CBR6C/D-S</b>	C/D	Orange	5,50
<b>CBR6D-S</b>	D	Grün/Green/Vert	5,75
<b>CBR6E-S</b>	E	Lila/Purple/Lilas	6,00

### FLECO Rapid Loader-Nieten · Rivets · Rivets BR10

Inhalt 60 Streifen / 1200 Nieten pro Eimer  
Content 60 strips / 1200 rivets per bucket  
Contenu 60 bandes / 1200 rivets par seau

Bestell-Nr. Order-No. No. de réf.	Größe Size Taille	Farbe Colour Couleur	Gewicht Weight Poids kg
---	-------------------------	----------------------------	----------------------------------

#### Stahl / Steel / Acier

<b>CSRLA</b>	A	Rot/Red/Rouge	5,89
<b>CSRLB</b>	B	Weiß/White/Blanc	6,31
<b>CSRLC</b>	C	Blau/Blue/Bleu	6,72
<b>CSRLC/D</b>	C/D	Orange	7,05
<b>CSRLD</b>	D	Grün/Green/Vert	7,28
<b>CSRLE</b>	E	Lila/Purple/Lilas	7,53
<b>CSRLF</b>	F	Gelb/Yellow/Jaune	7,86
<b>CSRLG</b>	G	Schwarz/Black/Noir	8,11

#### Rostfrei / Stainless / Inoxydable

<b>CSRLA-S</b>	A	Rot/Red/Rouge	5,84
<b>CSRLB-S</b>	B	Weiß/White/Blanc	6,25
<b>CSRLC-S</b>	C	Blau/Blue/Bleu	6,76
<b>CSRLC/D-S</b>	C/D	Orange	6,94
<b>CSRLD-S</b>	D	Grün/Green/Vert	7,21
<b>CSRLE-S</b>	E	Lila/Purple/Lilas	7,47
<b>CSRLF-S</b>	F	Gelb/Yellow/Jaune	7,67
<b>CSRLG-S</b>	G	Schwarz/Black/Noir	7,94



**Nieten Auswahltabelle**  
**Rivet Selection Chart**  
**Tableau de sélection des rivets**

Verbinder Fasteners Agrafes	Bandstärke Belt Thickness Epaisseur de bande	Größe Size Largeur
<b>BR-6</b>	6 - 8	<b>SRA</b>
	8 - 10,5	<b>SRB</b>
	9,5 - 12	<b>SRC</b>
	11 - 13,5	<b>SRC/D</b>
	13 - 15	<b>SRD</b>
	14 - 17	<b>SRE</b>
<b>BR-10</b>	6 - 8	<b>SRA</b>
	7 - 10	<b>SRB</b>
	9 - 11	<b>SRC</b>
	10 - 13	<b>SRC/D</b>
	12 - 14	<b>SRD</b>
	13 - 16	<b>SRE</b>
	15 - 17	<b>SRF</b>
<b>BR-14</b>	10 - 13	<b>SRD</b>
	12 - 14	<b>SRE</b>
	13 - 16	<b>SRF</b>
	15 - 17	<b>SRG</b>
	16 - 19	<b>SRH</b>
	18 - 21	<b>SRI</b>
	20 - 22	<b>SRJ</b>
	21 - 24	<b>SRK</b>

Preise der Nieten siehe Seite 15 und 18  
 Prices of rivets on page 15 and 18  
 Voir pages 15 et 18 pour les prix et les rivets

**Nieten pro Verbindung**  
**Rivets per Splice**  
**Rivets par jonction**

Bandbreite Belt Width Largeur de bande	BR-6	BR-10	BR-14
400	66	90	126
500	84	110	154
650	114	140	196
800	138	170	238
1000	174	220	308
1200	210	270	378
1400		310	434
1600		360	504
1800		410	574

**Montagegeräte · Installation Tools**  
**Outillage de montage**

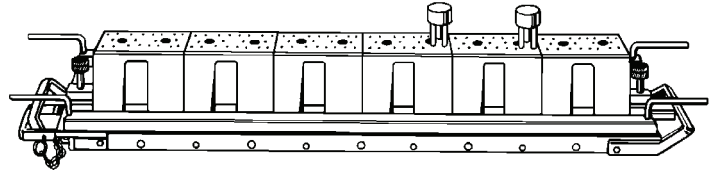

Bestell-Nr. Order-No. No. de réf.	Breite Width Largeur mm	Gewicht Weight Poids kg
---	----------------------------------	----------------------------------

MBRT6-Montagegeräte Aluminium für <b>BR6</b> MBRT6-Installation Tools Aluminium for <b>BR6</b> MBRT6-Outillage de montage en aluminium pour <b>BR6</b>		
<b>MBRT6-30-AL</b>	750	34,0
<b>MBRT6-36-AL</b>	900	38,5
<b>MBRT6-42-AL</b>	1050	42,0
<b>MBRT6-48-AL</b>	1200	48,0
<b>MBRT6-60-AL</b>	1500	54,5
<b>MBRT6-72-AL</b>	1800	67,0
<b>MBRT6-84-AL</b>	2100	71,0

MBRT10-Montagegeräte Aluminium für <b>BR10</b> MBRT10-Installation Tools Aluminium for <b>BR10</b> MBRT10-Outillage de montage en aluminium pour <b>BR10</b>		
<b>MBRT10-30-AL</b>	750	36,0
<b>MBRT10-36-AL</b>	900	40,5
<b>MBRT10-42-AL</b>	1050	44,0
<b>MBRT10-48-AL</b>	1200	47,5
<b>MBRT10-60-AL</b>	1500	56,0
<b>MBRT10-72-AL</b>	1800	64,0
<b>MBRT10-84-AL</b>	2100	73,0

MBRTA-Stahl Montagegeräte für <b>BR10 und BR14</b> MBRTA-Steel Installation Tools for <b>BR10 and BR14</b> MBRTA-Outillage de montage en acier pour <b>BR10 et BR14</b>		
<b>MBRTA-42*</b>	1050	57,0
<b>MBRTA-48*</b>	1200	75,5
<b>MBRTA-60*</b>	1500	81,0
<b>MBRTA-72</b>	1800	87,0
<b>MBRTA-84</b>	2100	103,0

\* mit Metallkoffer · with Tool Box · avec coffret métallique

**Ersatzteile und Zubehör**  
**Spare Parts and Accessories**  
**Pièces de rechange et accessoires**

Bestell-Nr. Order-No. No. de réf.	Gewicht Weight Poids kg
<b>BR300</b>	1,72
<b>BR359</b>	0,46
<b>BR500D</b>	1,36
<b>SR759</b>	0,44
<b>BR151</b>	0,23

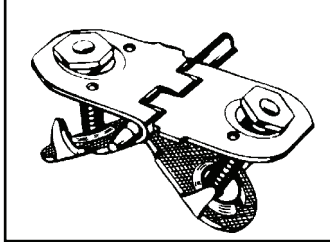

## FLEXCO Bolt Hinged

Transportband -  
Verbindungssystem  
für Bandstärken  
von 6 bis 16 mm

Conveyor Belt Fastening  
System for Belts  
6 to 16 mm thick

Système d'agrafage pour  
bandes transporteuses  
d'épaisseur 6 - 16 mm

Verbindergroße Fastener Size Taille des agrafes	Für Transportbänder bis zu... N/mm Festigkeit For Belts with a Tensile Strength of up to... N/mm Pour bandes tranporteuses à résistance de rupture jusqu'à... N/mm	empf. Bandstärkenbereich Belt Thickness Range Épaisseur de bandes recommandée mm	empf. kleinster Trommel-Ø rec. min. Pulley-Ø Ø tambour mini.rec. mm
<b>375X</b>	400	6 - 10	125
<b>550</b>	500	6 - 16	200

**Inhalt:** Jeder J-Karton enthält 1 komplette Verbindung für die angegebene Bandbreite.

**Content:** Each J-Box contains 1 Set Lacing for the Belt Width specified.

**Contenu:** Chaque boîte J contient 1 jeu complet de jonction pour la largeur de bande spécifiée.

### Stahl verzinkt / Galvanized Steel / Acier galvanisé

Bestell-Nr. Order-No. No. de réf.	Bandbreite Belt Width Larg. de bande mm	Gewicht Weight Poids kg
<b>375XJ400NC-SN</b>	400	1,28
<b>375XJ500NC-SN</b>	500	1,59
<b>375XJ650NC-SN</b>	650	2,07
<b>375XJ800NC-SN</b>	800	2,55
<b>375XJ1000NC-SN</b>	1000	3,18
<b>375XJ1200NC-SN</b>	1200	3,77
<b>375XJ1400NC-SN</b>	1400	4,46
<b>550J500NC-SN</b>	500	1,66
<b>550J650NC-SN</b>	650	2,16
<b>550J800NC-SN</b>	800	2,66
<b>550J1000NC-SN</b>	1000	3,32
<b>550J1200NC-SN</b>	1200	4,00
<b>550J1400NC-SN</b>	1400	4,65

### Rostfrei W.1.4401 / Stainless AISI 316 / Inoxydable Z6CND17-11

Bestell-Nr. Order-No. No. de réf.	Bandbreite Belt Width Larg. de bande mm	Gewicht Weight Poids kg
<b>375XSJ400NCS</b>	400	1,28
<b>375XSJ500NCS</b>	500	1,59
<b>375XSJ650NCS</b>	650	2,07
<b>375XSJ800NCS</b>	800	2,55
<b>375XSJ1000NCS</b>	1000	3,18
<b>375XSJ1200NCS</b>	1200	3,77
<b>375XSJ1400NCS</b>	1400	4,46
<b>550SJ500SSC</b>	500	1,66
<b>550SJ650SSC</b>	650	2,16
<b>550SJ800SSC</b>	800	2,66
<b>550SJ1000SSC</b>	1000	3,32
<b>550SJ1200SSC</b>	1200	4,00
<b>550SJ1400SSC</b>	1400	4,65
<b>550SJ650NB*</b>	650	2,16
<b>550SJ800NB*</b>	800	2,66
<b>550SJ1000NB*</b>	1000	3,32
<b>550SJ1200NB*</b>	1200	4,00
<b>550SJ1400NB*</b>	1400	4,50

### Everdur

antimagnetisch und funkenfrei  
non-magnetic and non-sparkling  
anti-magnétique et anti-étincelle

<b>375XEJ500NB</b>	500	1,59
<b>375XEJ650NB</b>	650	2,07
<b>375XEJ800NB</b>	800	2,55
<b>375XEJ1000NB</b>	1000	3,18
<b>375XEJ1200NB</b>	1200	3,77

\* Antimagnetisch / Non-magnetic / Anti-magnétique

### MegAlloy

<b>550MAJ650SC-SN</b>	500	1,6
<b>550MAJ650SC-SN</b>	650	2,1
<b>550MAJ800SC-SN</b>	800	2,7
<b>550MAJ1000SC-SN</b>	1000	3,3
<b>550MAJ1200SC-SN</b>	1200	4,0

### Lose-Verbinder (mit Schrauben und Muttern) / Bulk Fasteners (with Bolts and Nuts)

#### Plaques d'agrafes individuelles (avec vis et écrous)

##### Stahl verzinkt / Galvanized Steel / Acier galvanisé

Bestell-Nr. Order-No. No. de réf.	Platten Plates Plaques	Sets/Eimer Sets/Bucket Jeux/seau	Gewicht Weight Poids kg
<b>375X-3-SN</b>	3	18	3,86
<b>550-1-SN</b>	1	50	5,44
<b>550-3-SN</b>	3	18	5,90





##### Rostfrei W.1.4401 / Stainless AISI 316 / Inoxydable Z6CND17-11

Bestell-Nr. Order-No. No. de réf.	Platten Plates Plaques	Sets/Krt. Sets/Box Jeux/bte.	Gewicht Weight Poids kg
<b>375XS-2</b>	2	25	2,86
<b>375XS-3</b>	3	18	3,68
<b>550S-1</b>	1	50	5,49

Extra Kupplungsstäbe auf Seite 14  
Extra Hinge Pins on Page 14  
Tiges supplémentaires page 14

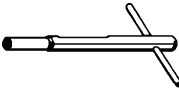
Extra Schrauben und Muttern auf Seite 25  
Extra Bolts and Nuts on Page 25  
Vis et écrous supplémentaires page 25

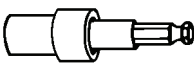
## Montagewerkzeuge · Installation Tools · Outils de montage

		Bestell-Nr. Order-No. No. de réf.	Verbindergroße Fastener Size Taille d'agrafe	Gewicht Weight Poids kg
<b>Manuelle Montage · Hand Tools · Montage manuel</b>				
	Schraubenbrecher Bolt Breaker Casse-vis	<b>110</b>	375 + 550	0,60
	Lochsen Punch Poinçon	<b>P1P</b>	375 + 550	0,06
	Schraubenschlüssel Wrench Clé à tube	<b>S1S</b>	375 + 550	0,09
<b>Für Schlagschrauber · Power Tools · Outils pour boulonneuse à percussion</b>				
	Lochsen Punch Poinçon	<b>HP1</b>	375 + 550	0,07
	Schraubenschlüssel Wrench Clé à tube	<b>HW1</b>	375 + 550	0,11
	Schnellkupplung Quick Change Chuck Mandrin serrage rapide	<b>5552</b>	375 + 550	0,16
	Füllschlauch orange (30 m) Orange Filler Tubing (30 m) Tuyau orange (30 m)	<b>30894</b>	375 + 550	0,36

## Bohrschablonen · Templets · Gabarits

Bestell-Nr. Order-No. No. de réf.	Bandbreite Belt Width Largeur de bande mm	Gewicht Weight Poids kg	Bestell-Nr. Order-No. No. de réf.	Bandbreite Belt Width Largeur de bande mm	Gewicht Weight Poids kg
<b>für/for/pour 375</b>			<b>für/for/pour 550</b>		
<b>375X-500</b>	500	1,05	<b>5-500</b>	500	1,05
<b>375X-650</b>	650	1,36	<b>5-650</b>	650	1,36
<b>375X-800</b>	800	1,68	<b>5-800</b>	800	1,68
<b>375X-1000</b>	1000	2,09	<b>5-1000</b>	1000	2,09
<b>375X-1200</b>	1200	2,51	<b>5-1200</b>	1200	2,51
<b>375X-1400</b>	1400	2,93	<b>5-1400</b>	1400	2,93

## Bandschneider, Serie 400 Belt Cutter 400 Series Coupeuse de bande Série 400

<b>400430</b>	750	6,42
<b>400436</b>	900	7,32
<b>400442</b>	1050	8,59
<b>400448</b>	1200	8,62
<b>400460</b>	1500	10,43

## FLEXCO-LOK Band FLEXCO-LOK Tape Bande FLEXCO-LOK

Bestell-Nr. Order-No. No. de réf.	für for pour	Länge Length Longueur m	Gewicht Weight Poids kg
<b>FL7C</b>	375X/550	30	0,36

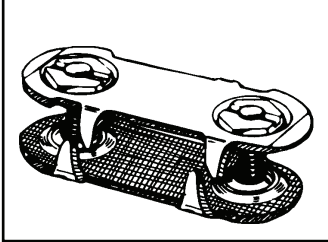

## FLESCO Bolt Solid Plate

Transportband -  
Verbindungssystem  
für Bandstärken  
von 5 bis 30 mm

Conveyor Belt Fastening  
System for Belts  
5 to 30 mm thick

Système d'agrafage pour  
bandes transporteuses  
d'épaisseur 5 - 30 mm

Verbindergroße Fastener Size Taille des agrafes	Für Transportbänder bis zu... N/mm Festigkeit For Belts with a Tensile Strength of up to... N/mm Pour bandes tranporteuses à résistance de rupture jusqu'à... N/mm	empf. Bandstärkenbereich Belt Thickness Range Épaisseur de bandes recommandée mm	empf. kleinster Trommel-Ø rec. min. Pulley-Ø Ø tambour mini.rec. mm
<b>1</b>	315	5 - 11	250
<b>140</b>	400	5 - 11	300
<b>190</b>	630	8 - 14	400
<b>1-1/2</b>	500	11 - 17	400
<b>2</b>	800	14 - 21	700
<b>2-1/4</b>	1000	14 - 30	850
<b>2-1/2</b>	800	19 - 25	1000
<b>3</b>	1000	24 +	1200

Bestell-Nr. Order-No. No. de réf.	Inhalt Content Contenu	Gewicht Weight Poids kg	Bestell-Nr. Order-No. No. de réf.	Inhalt Content Contenu	Gewicht Weight Poids kg
<b>Stahl / Steel / Acier</b>			<b>Stahl / Steel / Acier</b>		
<b>1E</b>	25	1,32	<b>1C</b>	100	4,94
<b>140E</b>	25	2,08	<b>140C</b>	100	7,12
<b>190E</b>	25	2,17	<b>190C</b>	100	8,39
<b>1-1/2E</b>	25	2,68	<b>1-1/2C</b>	100	9,93
<b>2E</b>	25	3,63	<b>2C</b>	100	13,74
<b>2-1/4E</b>	25	4,89			
<b>2-1/2</b>	10	2,90			
<b>3</b>	10	3,18			

Bestell-Nr. Order-No. No. de réf.	Inhalt Content Contenu	Gewicht Weight Poids kg	Bestell-Nr. Order-No. No. de réf.	Inhalt Content Contenu	Gewicht Weight Poids kg
<b>MegAlloy</b> Oberplatten/Top Plates/plaquettes supérieures			<b>MegAlloy</b>		
<b>140EMA</b>	25	2,08	<b>140CMA</b>	100	7,12
<b>190EMA</b>	25	2,17	<b>190CMA</b>	100	8,39
<b>1-1/2EMA</b>	25	2,68	<b>1-1/2CMA</b>	100	9,93
<b>2EMA</b>	25	3,63	<b>2CMA</b>	100	13,74

<b>Rostfrei W.1.4401</b> (antimagnetisch) <b>Stainless AISI 316</b> (non-magnetic) <b>Inoxydable Z6CND17-11</b> (anti-magnétique)			<b>Reparatur-Set</b> Eimer mit 50 Verbindern, HP1, HW1, 110 und ca. 5 m LOK-Band		
<b>140ES</b>	25	2,08	<b>Repair Set</b> Bucket containing 50 fasteners, HP1, HW1, 110 and approx. 5 m LOK Tape		
<b>190ES</b>	25	2,17	<b>Jeu de réparation</b> Seau avec 50 agrafes, HP1, HW1, 110 et env. 5 m de bande LOK		
<b>1-1/2ES</b>	25	2,68			
<b>2ES</b>	25	3,63			

<b>Everdur</b> (antimagnetisch und funkenfrei) (non-magnetic and non-sparkling) (anti-magnétique et anti-étincelle)			<b>FVS 140</b>	6,24
<b>140EE</b>	25	2,08	<b>FVS 190</b>	6,51
<b>190EE</b>	25	2,17		
<b>1-1/2EE</b>	25	2,68		
<b>2EE</b>	25	3,63		

Bandbreite Belt Width Largeur de bande mm	Grösse Size Taille		Grösse Size Taille		Grösse Size Taille	
	1, 140, 190		1-1/2, 2, 2-1/4		2-1/2, 3	
	90°	45°	90°	45°	90°	45°
400	13	19	10	15	8	12
500	16	26	13	21	10	16
650	21	33	17	27	14	21
800	26	40	21	32	17	26
1000	32	45	26	36	21	29
1200	39	54	31	43	26	35
1400	46	71	37	51	30	40



### VP-Vulcanized Plate

Bestell-Nr. Order-No. No. de réf.	Bandbreite Belt Width Largeur de bande mm	Gewicht Weight Poids kg
<b>140VP</b>	900 (5 X 180 mm)	2,48
<b>190VP</b>	900 (5 X 180 mm)	2,62
<b>2VP</b>	900 (5 X 180 mm)	3,58

## FLEXCO Wedlock Verbindung\* · FLEXCO Wedlock Splice\* · FLEXCO Agrafes Wedlock\*

\*Weitere Informationen vgl. Broschüre FW/200 · More information in bulletin FW/200 · Plus d'information dans le bulletin FW/200

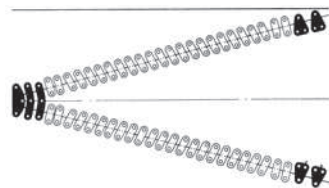

Bestell-Nr. Order-No. No. de réf.		Gewicht Weight Poids kg
<b>2W</b>	Verbinderset – Splice Kit – Jeu d'agrafes	1,81
<b>2WS</b>	Verbinderset rostfrei – Stainless Splice Kit – Jeu d'agrafes inoxydable	1,81
<b>2WL</b>	Verbinderset Zugseite – Leading End Kit – Jeu d'agrafes extrémité tirante	1,36
<b>2WT</b>	Verbinderset gezogene Seite – Trailing End Kit – Jeu d'agrafes extrémité tirée	1,32
<b>T2W</b>	Bohrschablonenset – Wedlock Template Set – Jeu de gabarits	2,86

## Rißreparaturverbinder · Rip Repair Fasteners · Agrafes pour réparation de déchirure

Bestell-Nr. Order-No. No. de réf.	Inhalt Content Contenu	Gewicht Weight Poids kg	Bestell-Nr. Order-No. No. de réf.	Inhalt Content Contenu	Gewicht Weight Poids kg
<b>Stahl / Steel / Acier</b>			<b>Rostfrei W.1.4401</b> (antimagnetisch)		
<b>RP1E</b>	25	2,14	<b>Stainless AISI 316</b> (non-magnetic)		
<b>RP2E</b>	25	4,64	<b>Inoxydable Z6CND17-11</b> (anti-magnétique)		
<b>16</b>	50	1,96	<b>RP1ES</b>	25	2,24
			<b>RP2ES</b>	25	4,57

## SS Sechszackverbinder Stahl · Sixpoint Fasteners Steel · Agrafes à griffes acier

Bestell-Nr. Order-No. No. de réf.	Stück Pieces Pièces mm	Bandstärke Belt Thickness Epais. de bande mm	Spitzenlänge Point Length Longueur Pointes
<b>SS200</b>	100	2,5 - 4	8
<b>SS201</b>	100	4 - 6	10
<b>SS202</b>	100	6 - 8	12
<b>SS203</b>	100	8 - 10	15
<b>SS204</b>	100	10 - 13	20
<b>SS205</b>	100	13 - 15	23
<b>SS206</b>	100	15 - 18	27
<b>SS207</b>	100	18 - 21	35

## Bohrschablonen · Templets · Gabarits

Bestell-Nr. Order-No. No. de réf.	Bestell-Nr. Order-No. No. de réf.	Bestell-Nr. Order-No. No. de réf.	Bandbreite Belt Width Largeur de bande mm	Gewicht Weight Poids kg
<b>1-500</b>	<b>140-500</b>	<b>190-500</b>	500	1,0
<b>1-650</b>	<b>140-650</b>	<b>190-650</b>	650	1,3
<b>1-800</b>	<b>140-800</b>	<b>190-800</b>	800	1,6
<b>1-1000</b>	<b>140-1000</b>	<b>190-1000</b>	1000	2,0
<b>1-1200</b>	<b>140-1200</b>	<b>190-1200</b>	1200	2,4
<b>1-1400</b>	<b>140-1400</b>	<b>190-1400</b>	1400	2,8
<b>1-1/2-800</b>	<b>2-800</b>		800	1,6
<b>1-1/2-1000</b>	<b>2-1000</b>		1000	2,0
<b>1-1/2-1200</b>	<b>2-1200</b>		1200	2,4
<b>1-1/2-1400</b>	<b>2-1400</b>		1400	2,8
<b>2-1/4-800</b>	<b>2-1/2-800</b>	<b>3-800</b>	800	1,6
<b>2-1/4-1000</b>	<b>2-1/2-1000</b>	<b>3-1000</b>	1000	2,0
<b>2-1/4-1200</b>	<b>2-1/2-1200</b>	<b>3-1200</b>	1200	2,4
<b>2-1/4-1400</b>	<b>2-1/2-1400</b>	<b>3-1400</b>	1400	2,8



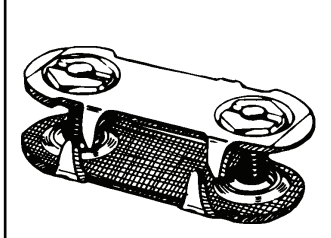

**Montagewerkzeuge  
für FLEXCO  
Bolt Solid Plate**

**Installation Tools  
for FLEXCO  
Bolt Solid Plate**

**Outillage de montage  
pour FLEXCO  
Bolt Solid Plate**

		Bestell-Nr. Order-No. No. de réf.	Verbindergröße Fastener Size Taille d'agrafe	Gewicht Weight Poids kg
<b>Manuelle Montage · Hand Tools · Montage manuel</b>				
	Schraubenbrecher	<b>110</b>	1, 140, 190, RP1, 375X, 550	0,60
	Bolt Breaker	<b>112</b>	1-1/2, 2, 2-1/4, RP2	0,66
	Casse-vis	<b>113</b>	2-1/2, 3	0,90
	Locheisen	<b>P1P</b>	1, 140, 190, RP1, 375X, 550	0,06
	Punch	<b>P2P</b>	1-1/2, 2, 2-1/4, RP2	0,10
	Poinçon	<b>P3P</b>	2-1/2, 3	0,13
	Steckschlüssel	<b>S1S</b>	1, 140, 190, RP1, 375X, 550	0,09
	Wrench	<b>S2S</b>	1-1/2, 2, 2-1/4, RP2	0,09
	Clé à tube	<b>S3S</b>	2-1/2, 3	0,11
	Schraubhorn	<b>2BH</b>		0,02
	Meißel	<b>C1C</b>	1, 140, 190, RP1, 375X, 550	0,54
	Cracking Chisel	<b>C2C</b>	1-1/2, 2, 2-1/4, RP2	0,54
	Locheisen	<b>HP1</b>	1, 140, 190, RP1, 375X, 550	0,07
	Punch	<b>HP2</b>	1-1/2, 2, 2-1/4, RP2	0,07
	Poinçon	<b>HP3</b>	2-1/2, 3	0,10
	Steckschlüssel	<b>HW1</b>	1, 140, 190, RP1, 375X, 550	0,11
	Wrench	<b>HW2</b>	1-1/2, 2, 2-1/4, RP2	0,14
	Clé à tube	<b>HW3</b>	2-1/2, 3	0,17
	Schnellkupplung	<b>5552</b>	für HP + HW Werkzeuge	0,16
	Quick Change Chuck		for HP + HW Tools	
	Mandrin serrage rapide		pour Outillage HP + HW	
	Silikon Spray	<b>SL5-1</b>		0,62
	Silicone Spray			
	Silicone			
<b>FLEXCO-LOK Band · FLEXCO-LOK Tape · Bande FLEXCO-LOK</b>				
	Bestell-Nr.	für	Länge	Gewicht
	Order-No.	for	Length	Weight
	No. de réf.	pour	Longueur	Poids
			m	kg
	<b>FL7C</b>	1, 140	30	0,36
	<b>FL11C</b>	190, 1-1/2, 2, 2-1/4, 2-1/2, 3	30	0,45
	Makita Schlagschrauber	Makita Impact Tool	Boulonreuse Makita	
	Nr. TW 0350	Nr. TW 0350	n° TW 0350	

**Extra Schrauben  
und Muttern**

**Extra Bolts and Nuts**

**Vis et écrous  
supplémentaires**

**Extra Schrauben  
Extra Bolts  
Vis supplémentaires**

**Stahl / Steel / Acier**

Bestell-Nr. Order-No. No. de réf.	Verbindergröße Fastener Size Taille des agrafes	Gewicht Weight Poids kg
<b>20391</b>	1	0,80
<b>20398</b>	RP1, 375X	1,10
<b>20399</b>	140, 190, 550	1,00
<b>20402</b>	1-1/2	1,50
<b>20406</b>	2, RP2	1,80
<b>20410</b>	2-1/4	2,20
<b>20414</b>	2-1/2, 3	3,40

**Rostfrei / Stainless / Inoxydable**

<b>20400</b>	140, 190, 375X, 550, RP1	1,50
<b>20407</b>	1-1/2, 2, RP2	1,80
<b>20411</b>	2-1/4	2,20

**Everdur**

<b>20397</b>	140, 190	0,84
<b>20409</b>	1-1/2, 2, RP2	1,68

**Extra Muttern  
Extra Nuts  
Écrous supplémentaires**

**Stahl / Steel / Acier**

Bestell-Nr. Order-No. No. de réf.	Verbindergröße Fastener Size Taille des agrafes	Gewicht Weight Poids kg
<b>20377</b>	1, 140, 190, RP1 + 375X, 550	0,30
<b>20378</b>	1-1/2, 2, 2-1/4, RP2	0,50
<b>20379</b>	2-1/2, 3	1,00

**Rostfrei / Stainless / Inoxydable**

<b>20381</b>	1, 140, 190, RP1 + 375X, 550	0,30
<b>20382</b>	1-1/2, 2, 2-1/4, RP2	0,50

**Everdur**

<b>20387</b>	1, 140, 190, RP1 + 375X	0,30
<b>20388</b>	1-1/2, 2, 2-1/4, RP2	0,50

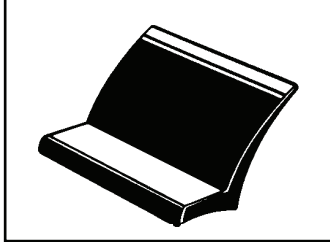



## TATCH A CLEAT





Schraubstollen und  
Führungsprofile

Mechanical Belt  
Cleats and Guides

Profils à vis et de  
guidage

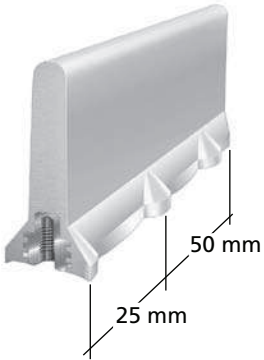
	<b>Hinweis:</b> Weitere Informationen finden Sie in unserer Broschüre TAC 100.	<b>Notice:</b> For further information see our Brochure TAC 100.	<b>Renvoi:</b> Pour d'autres informations veuillez consulter notre brochure TAC 100.			
Tatch-A-Cleat	Zusammensetzung Compound Composition	Min. Trommel-Ø Min. Pulley-Ø Ø tambour mini mm	Temperatur- einsatzbereich Temperature Service Range Température Rayon d'action	Abriebbeständigkeit Abrasion Resistance Résistance à l'abrasion	Ölbeständigkeit Oil Resistance Résistance à l'huile	Säurebeständigkeit Acid Resistance Résistance aux acides
<b>L</b>	Weiß/Schwarz Nitril - FDA White/Black Nitril - FDA blanc/noir nitril - FDA	50	-40° bis / up to / jusqu'à + 110° C	+	++	+
<b>EC</b>	Schwarz EPDM Black EPDM noir EPDM	EC1-3: 75 EC4: 100 EC6: 150	-55° bis / up to / jusqu'à + 150° C	++	N/A	++
<b>HD</b>	Schwarz SBR Black SBR noir SBR	75	-40° bis / up to / jusqu'à + 80° C	++	N/A	0
<b>LUG/PEG</b>	Tan Isopren FDA Tan Isoprene FDA tan isoprène FDA	80	-40° bis / up to / jusqu'à + 80° C	++	N/A	+
<b>GUIDE</b>	Schwarz Neopren Black Neoprene noir neoprène	A: 100 B: 150 C: 200	-40° bis / up to / jusqu'à + 110° C	+	+	+

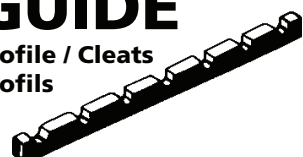
<b>HD</b> Profile Cleats Profils		Bestell-Nr. Order-No. No. de Réf.	Höhe Height Hauteur mm	Inhalt Content Contenu	Gewicht Weight Poids kg	
	Schwarz, verzinkte Schrauben Black, plated Fasteners Noir, vis galvanisées	<b>HD-1</b> <b>HD-2</b>	25 50	10X610 mm 5X610 mm	5,22 4,30	
	Schwarz, rostfreie Schrauben Black, stainless Fasteners Noir, vis inoxydables	<b>HD-1S</b> <b>HD-2S</b>	25 50	10X610 mm 5X610 mm	5,35 4,30	
	<b>Extra Schrauben und Unterlegscheiben Extra Bolts and Washers Vis et rondelles supplémentaires</b>	verzinkt, plated, galvanisées	<b>HD1-F</b> <b>HD1-1/4-F</b>	25 32,5	123 123	1,24 1,50
	rostfrei, stainless, inoxydables	<b>HD1-FS</b> <b>HD1-1/4-FS</b>	25 32,5	123 123	1,24 1,50	
	Schwarz, verzinkte Schrauben Black, plated Fasteners Noir, vis galvanisées	<b>EC1-1/4</b> <b>EC2</b> <b>EC3</b> <b>EC4</b> <b>EC6</b>	32 51 76 102 152	5X1220 mm   2X1220 mm	5,67 7,03 9,98 14,97 12,84	
	<b>Extra Schrauben Extra Bolts Vis supplémentaires</b>	verzinkt, plated, galvanisées	<b>ECF</b> <b>EC4F</b> <b>EC6F</b> <b>ECFS</b>	61 61 33 61	1,27 1,50 0,91 1,32	

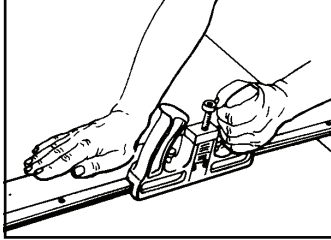

		Bestell-Nr. Order-No. No. de réf.	Höhe Height Hauteur mm	Inhalt Content Contenu	Gewicht Weight Poids kg			
<b>L Profile Cleats Profils</b> 	Schwarz, verzinkte Schrauben Black, plated Fasteners Noir, vis galvanisées	<b>L5/8-B</b> <b>L1-B</b> <b>L1-1/2-B</b> <b>L2-B</b> <b>L3-B</b>	16 25 38 54 76	10X610 mm	3,31 4,22 5,08 6,35 8,31			
	Schwarz, rostfreie Schrauben Black, stainless Fasteners Noir, vis inoxydables	<b>L5/8-BS</b> <b>L1-BS</b> <b>L1-1/2-BS</b> <b>L2-BS</b> <b>L3-BS</b>	16 25 38 54 76	10X610 mm	3,31 4,22 5,08 6,35 8,31			
	Weiß, verzinkte Schrauben White, plated Fasteners Blanc, vis galvanisées	<b>L5/8-W</b> <b>L1-W</b> <b>L1-1/2-W</b> <b>L2-W</b> <b>L3-W</b>	16 25 38 54 76	10X610 mm	3,31 4,22 5,58 6,58 8,75			
	Weiß, rostfreie Schrauben White, stainless Fasteners Blanc, vis inoxydables	<b>L5/8-WS</b> <b>L1-WS</b> <b>L1-1/2-WS</b> <b>L2-WS</b> <b>L3-WS</b>	16 25 38 54 76	10X610 mm	3,31 4,22 5,58 6,58 8,75			
	<b>Extra Schrauben und Unterlegscheiben für L/LUG/PEG</b> <b>Extra Bolts and Washers for L/LUG/PEG</b> <b>Vis et rondelles supplémentaires pour L/LUG/PEG</b>	Bandstärkenbereich Belt Thickness Range Épaisseur de bande	verzinkt / plated / galvanisées <b>L1/2-F</b> <b>L5/8-F</b> <b>L3/4-F</b>	12 16 19	123 123 123	0,45 0,45 0,59		
		L1/2-F/FS -8 mm L5/8-F/FS 7-11 mm L3/4-F/FS >11 mm	rostfrei / stainless / inoxydables <b>L1/2-FS</b> <b>L5/8-FS</b> <b>L3/4-FS</b>	12 16 19	123 123 123	0,45 0,45 0,59		
	<b>LUG Profile Cleats Profils</b> 	<b>PEG Profile Cleats Profils</b> 	<b>LG1-1/2-C</b>	38	100	3,00		
			<b>LG-2-C</b>	51	100	3,21		
			<b>PG2</b>	51	100	1,95		
			<b>PG3</b>	76	100	3,13		
				rostfreie Schrauben / stainless bolts / vis inoxydables	<b>PG2S</b> <b>PG3S</b>	51 76	100 100	1,95 3,13
			<b>GUIDE Profile / Cleats Profils</b> 	Schwarz, verzinkte Schrauben Black, plated Fasteners Noir, vis galvanisées	<b>A10</b> <b>B10</b> <b>C10</b>	13X10 16X12 26X16	10X200 mm	0,45 0,59 1,49
	Schwarz, rostfreie Schrauben Black, stainless Fasteners Noir, vis inoxydables	<b>A10S</b> <b>B10S</b> <b>C10S</b>		13X10 16X12 26X16	10X200 mm	0,45 0,59 1,49		
	<b>Extra Unterlegscheiben</b> <b>Extra Washers</b> <b>Rondelles supplémentaires</b>	verzinkt, plated, galvanisées Rostfrei / Stainless / Inoxydable		<b>CW1024</b> <b>CWS1024</b>	L/LUG/PEG L/LUG/PEG	100 100	0,20 0,20	
	verzinkt, plated, galvanisées Rostfrei / Stainless / Inoxydable	<b>CW25/100</b> <b>CWS25/100</b>		HD/EC HD/EC	100 100	0,40 0,40		
								



**ALLIGATOR/FLEXCO  
Bandschneider und  
Zubehör**

**ALLIGATOR/FLEXCO  
Belt Cutters and  
Accessories**

**ALLIGATOR/FLEXCO  
Coupeuses de bande  
et Accessoires**

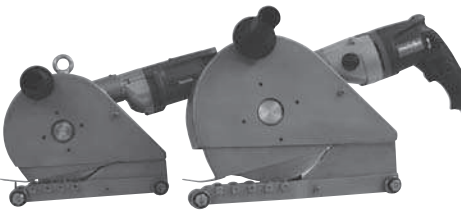
		Bestell-Nr. Order-No. No. de réf.	Breite Width Largeur mm	Gewicht Weight Poids kg	
<b>300 Serie Bandschneider</b> <b>300 Series Belt Cutter</b> <b>Série 300 Coupeuse de bande</b> 	für Bänder bis 30 mm	<b>300324</b>	600	8,00	
	for belts up to 30 mm	<b>300330</b>	750	8,70	
	pour bandes jusqu'à 30 mm	<b>300336</b>	900	9,00	
		<b>300342</b>	1050	11,80	
		<b>300348</b>	1200	16,00	
		<b>300360</b>	1500	14,90	
		<b>300372</b>	1800	17,00	
		<b>30023</b>	Klinge/Blade/Lame	0,10	
		<b>300</b>	Griff/Handle/Manche	1,10	
		<b>8D</b>	Nägel/Nails/Clous	0,50	
<b>900 Serie Bandschneider</b> <b>900 Series Belt Cutter</b> <b>Série 900 Coupeuse de bande</b> 	für Bänder bis 38 mm	<b>900924</b>	600	12,00	
	for belts up to 38 mm	<b>900936</b>	900	14,00	
	pour bandes jusqu'à 38 mm	<b>900948</b>	1200	17,00	
		<b>900960</b>	1500	19,00	
		<b>900972</b>	1800	14,00	
		<b>900984</b>	2100	17,00	
		<b>900CBK</b>	Klinge/Blade/Lame Rechtw. Anschlagsschiene Squaring device Jeu d'équerres	19,00 0,10	
	<b>Ersatzteile für 820, 840, 845LD Bandschneider</b>				
	<b>Spare Parts for 820, 840, 845LD Belt Cutters</b>				
	<b>Pièces de rechange pour coupeuses de bande 820, 840, 845LD</b>				
		<b>820/840-1CB</b>	Klinge/Blade/Lame	0,10	
		<b>845-1CB</b>	Klinge/Blade/Lame	0,10	
		<b>840SD</b>	Rechtw. Anschlagsschiene Squaring device Jeu d'équerres	0,10	
<b>Elektro Bandschneider</b> <b>Electric Belt Cutter</b> <b>Coupeuse de bande électrique</b> 	230 V / 50 Hz	<b>ITEC-170</b>	Schnitttiefe max. 25 mm Cut Depth max. 25 mm Capacité de coupe max. 25 mm	16,00	
		<b>ITEC-170C</b>	mit 2 Akkupacks with 2 accu packs avec 2 accus <b>21,6 V/3,0 Ah/54 Wh</b>	21,00	
		<b>ITEC-220</b>	Schnitttiefe max. 50 mm Cut Depth max. 50 mm Capacité de coupe max. 50 mm	20,00	
		<b>ITEC-220C</b>	mit 2 Akkupacks with 2 accu packs avec 2 accus <b>36,0 V/2,2 Ah/79 Wh</b>	25,00	
	<b>Ersatzmesser - Spare Blades - Lames de rechange</b>				
			<b>ITEC-170-BLADE</b>	für / for / pour ITEC-170	1,00
			<b>ITEC-220-BLADE</b>	für / for / pour ITEC-220	1,50

<b>Rauhmaschine elektrisch</b> <b>Electric Buffing Machine</b> <b>Machine électrique à meuler</b> 	230 V / 50 Hz	<b>ITMBM</b>		19,00
		<b>VW110-390-4</b>	Satz mit 4 Rauhscheiben Set of 4 vain wheels Jeu de 4 meuleuses	1,60



Bandhobel  
Belt Skiver  
Rabot pour bande

Bestell-Nr.  
Order-No.  
No. de réf.

**FSK-2**  
**FSK-1B**  
**FSK-2A**  
**FSK-1BA**

Hobel/Skiver/Rabot  
Klinge/Blade/Lame  
Hobel/Skiver/Rabot  
Klinge/Blade/Lame

Gewicht  
Weight  
Poids  
kg

9,30  
0,10  
9,30  
0,10

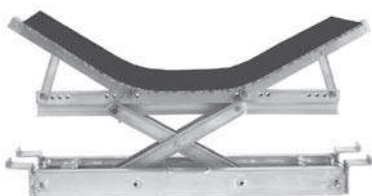

Gurtheber  
FLEX-Lifter  
Élévateur de bande

Bestell-Nr.  
Order-No.  
No. de réf.

**FLEX-LIFTER M**  
**FLEX-LIFTER L**  
**FLEX-LIFTER XL**

für Bandbreite von  
for Belt Width of  
pour largeur de bande de  
mm

900 - 1500  
1200 - 1800  
1800 - 2400

Gewicht  
Weight  
Poids  
kg

28,00  
34,00  
57,00



Akkuschrauber  
für Flex-Lifter  
**DeWalt 18V**

Cordless Drill  
for Flex-Lifter  
**DeWalt 18V**

Visseuse sans fil  
pour Flex-Lifter  
**DeWalt 18V**

Bandspannsysteme  
Far-Pull Belt Clamps  
Pinceur de bande

Bestell-Nr.  
Order-No.  
No. de réf.

**LSHD30/750**  
**LSHD36/900**  
**LSHD42/1050**  
**LSHD48/1200**  
**LSHD60/1500**  
**LSHD72/1800**  
**LSHD84/2100**  
**LSHD96/2400**

Bandbreite  
Belt Width  
Largeur de bande  
mm

750  
900  
1050  
1200  
1500  
1800  
2100  
2400

Gewicht  
Weight  
Poids  
kg

29,50  
32,50  
35,00  
39,00  
44,00  
48,00  
54,00  
60,00

Klemmbalkenset (2 Stück)  
Belt Clamp Bar Set (2 Pieces)  
Jeu de barres (2 pièces)

**LSHDB30/750**  
**LSHDB36/900**  
**LSHDB42/1050**  
**LSHDB48/1200**  
**LSHDB60/1500**  
**LSHDB72/1800**  
**LSHDS Klemme / Scissors / Pinces**

750  
900  
1050  
1200  
1500  
1800

9,00  
10,50  
12,00  
13,50  
16,50  
18,00  
2,75



4 Bandklemmen für Bänder  
bis 8 mm Bandstärke  
4 smart clamps for belts  
up to 8 mm belt width  
Jeu de 4 pinceurs de bande  
pour des bandes jusqu'à un  
épaisseur de 8 mm

**SMARTCLAMP**

21,00



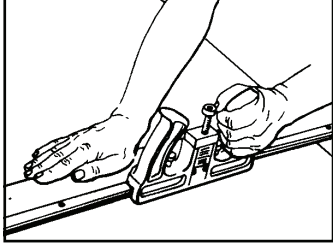

Zubehör für die Band-  
wartung

Belt Maintenance Tools

Outillage pour la  
maintenance des bandes

		Bestell-Nr. Order-No. No. de réf.	Gewicht Weight Poids kg
	Kupplungsstabschneider Hinge Pin Cutter Pince à couper les axes de jonction	<b>APC-1</b>	0,23
	Bandeckentrimmzange Belt Nippers Pince à rogner	<b>BN-1</b>	0,36
	Rillenhobel Hand Skiver Rabot pour courroie	<b>RTBS-F</b>	0,06
	Bandschleifer Belt Grinder Meule pour bande	<b>RB-1</b>	0,34
	Bandhalter (Paar) Belt Grip (Pair) Poignée pour bande (Jeux)	<b>22</b>	1,13
	Bandkehrer Belt Grover Rabot pour bande	<b>FBG1 HSP3</b>	0,82 0,02
	Silikon Spray Silicon Spray Silicone	<b>SL5-1</b>	0,62
	Bandmarkierstift Belt Marker Marqueur de bande	<b>M4</b>	0,01

Zubehör für die Band-  
wartung

Belt Maintenance Tools

Outils pour la  
maintenance des bandes

**Locheisensatz  
Belt Punch Set  
Coffret de poinçons**



Bestell-Nr.  
Order-No.  
No. de réf.  
(6 - 24 mm)

Gewicht  
Weight  
Poids  
kg

**LS-1/06-24**

1,36

**Ersatz Locheisen / Spare Belt Punches /  
Poinçons de rechange**

Bestell-Nr. Order-No. (No. de réf.)	Ø mm	Gewicht Weight Poids kg
<b>L-06</b>	6	0,06
<b>L-08</b>	8	0,06
<b>L-10</b>	10	0,06
<b>L-12</b>	12	0,12
<b>L-14</b>	14	0,12
<b>L-16</b>	16	0,12
<b>L-18</b>	18	0,18
<b>L-20</b>	20	0,18
<b>L-22</b>	22	0,18
<b>L-24</b>	24	0,18
<b>L-26</b>	26	0,25
<b>L-28</b>	28	0,25
<b>L-30</b>	30	0,25